

BIG

ENGLISH



مرجع آموزش زبان ایرانیان



Linnette Ansel • Lisa Broomhead

Mario Herrera • Christopher Sol Cruz

ACTIVITY BOOK

ALWAYS LEARNING

PEARSON

BIG

ENGLISH



Contents

	Welcome to class!	2
1	My Family	4
2	Happy Birthday!	14
3	I like cake!	24
	Checkpoint Units 1-3.....	34
4	My Body	36
5	Around Town	46
6	She's swinging on the swings!	56
	Checkpoint Units 4-6.....	66
7	It's sunny!	68
8	My House	78
9	A fish can swim!	88
	Checkpoint Units 7-9.....	98
	Picture Dictionary	100
	Stickers	

Welcome to class!

www.irLanguage.com



Listen and match.

1

2

3

4

a



b



c



d



2 Count and write. Say.



3

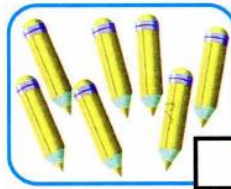

3 Draw and write how old you are. Say.

4 Listen and colour.

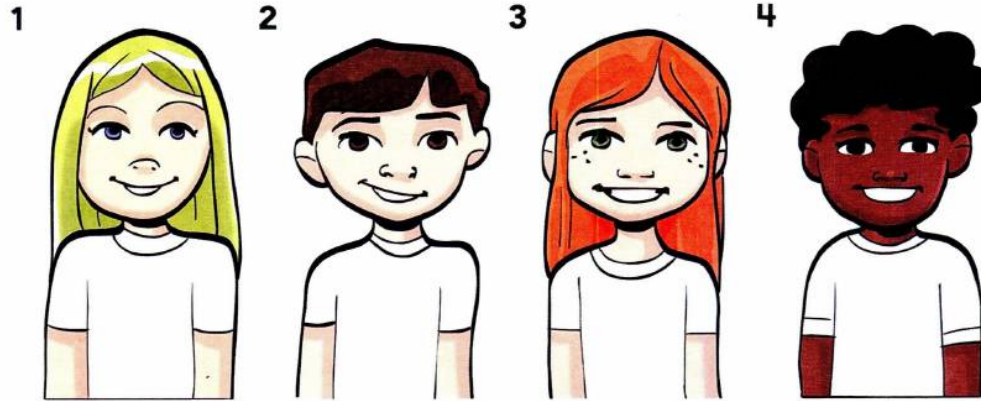

5 Listen and ✓ or ✗.

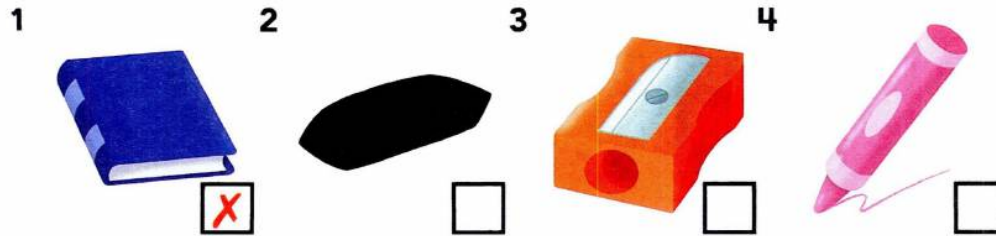

6 Complete and say.

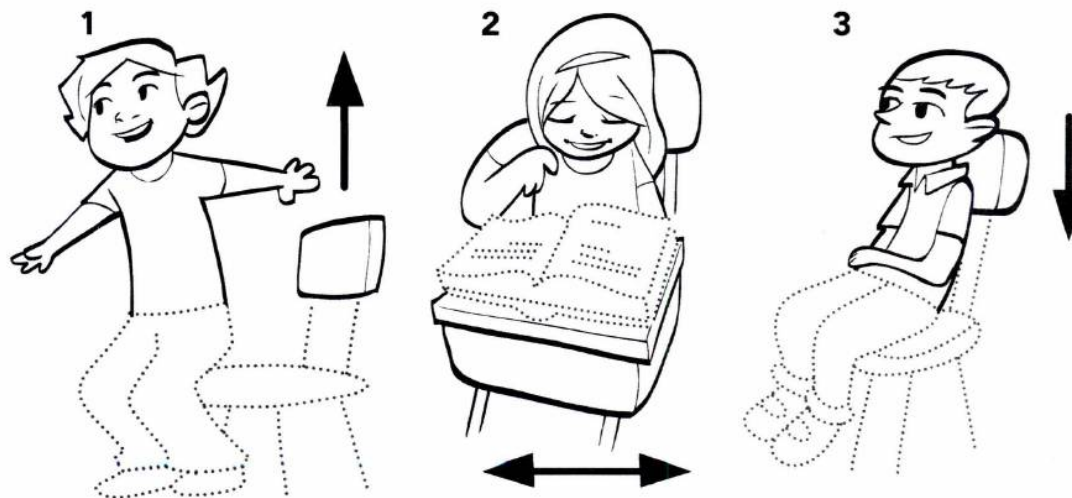

unit
1

My Family

1 Listen and circle.



2 Match and say.

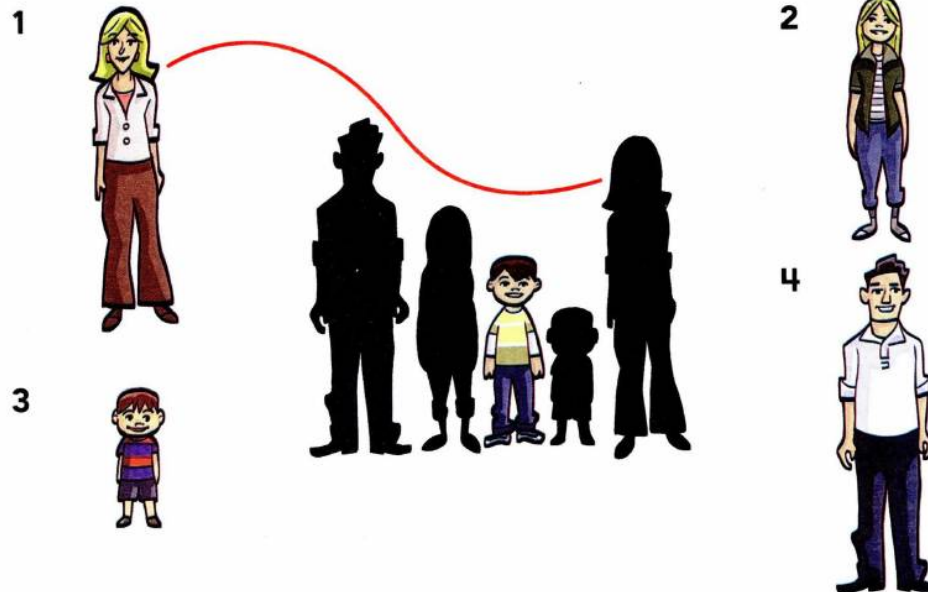

1:22 **3** Look and number. Sing. 🎵

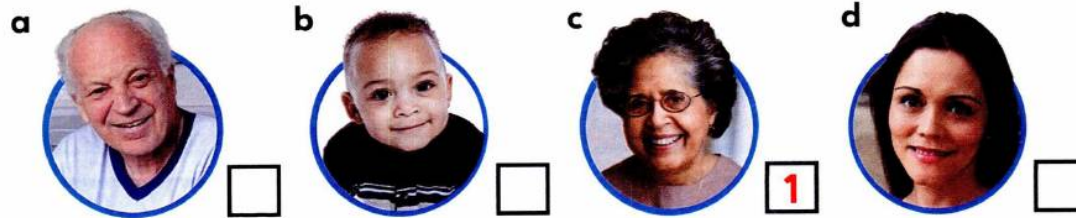
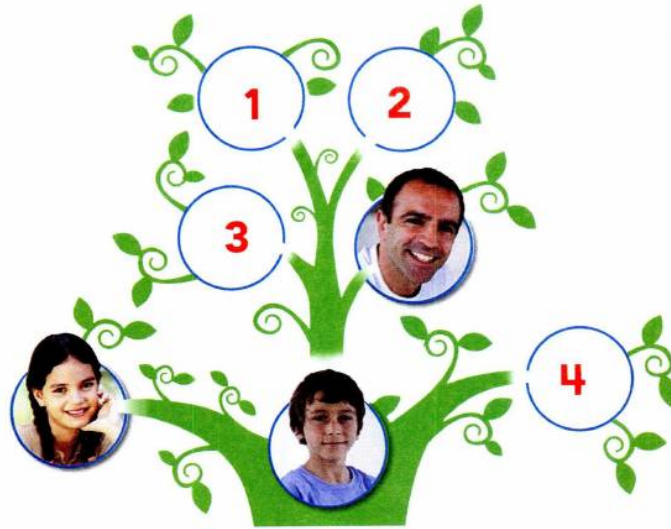

**THINK
BIG**

Who's missing? Draw and say.



مرجع زبان ایرانیان

4 Number in order. Tell the story.



5 Listen and colour.



1



2

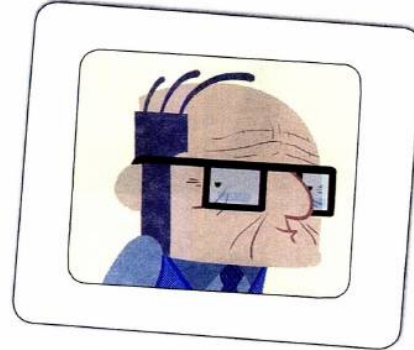

3



4



5



6

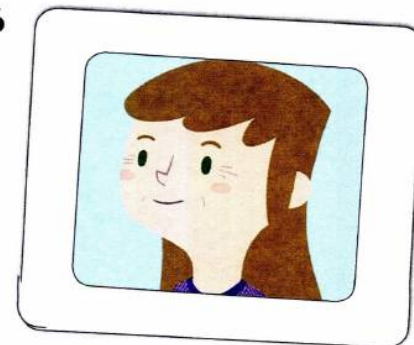



6 Listen and number.

a

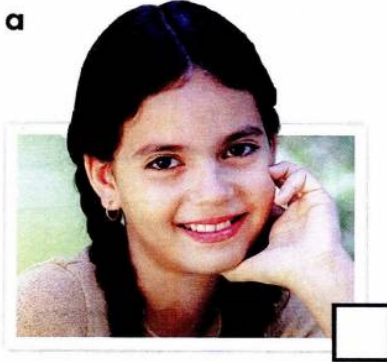

b



c



d

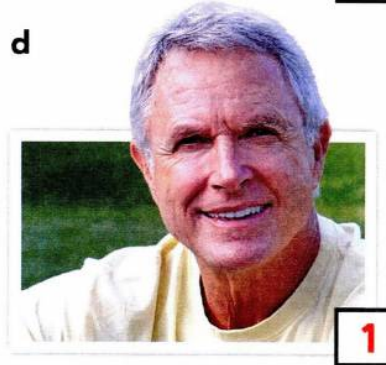

7 Draw and say.



8 Listen and ✓ or X.

1



2



3



4



THINK Look and match.
BIG

مرجع زبان ایرانیان

1

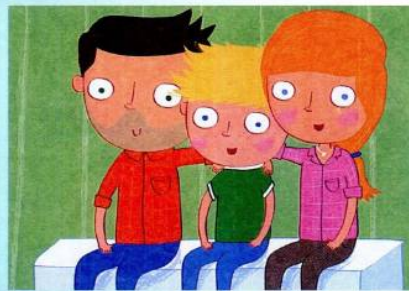

a



b



c



9 Look and draw. Say.

1 a



X

b



✓

2 a



X

b



✓

3 a



X

b



✓

10 Look and match.

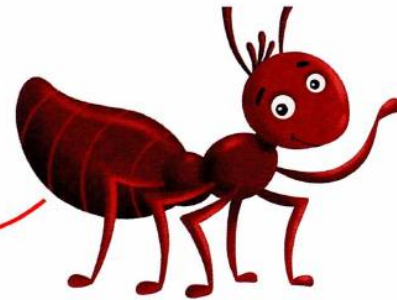

11 Circle the odd one out. Say.

1



2



3



4



 Listen and ✓.

1 a



b



2 a



b



3 a



b



4 a



b



unit
2

Happy Birthday!

1 Listen, find and colour.

1



2

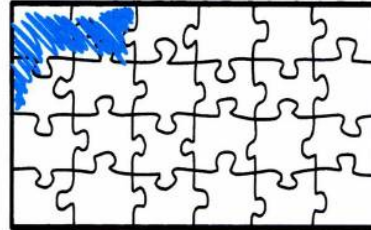

3



4



2 Complete and say.

1

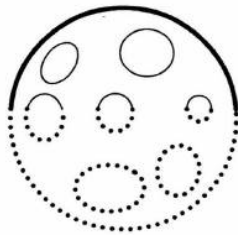

2



3



4



3 Listen and number in order. Sing. 🎵

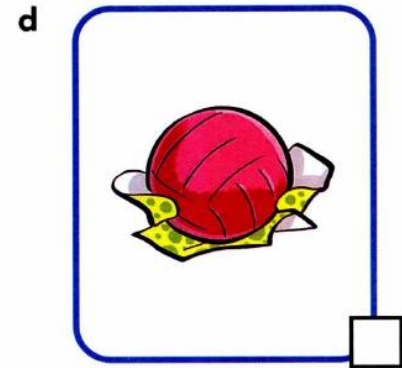
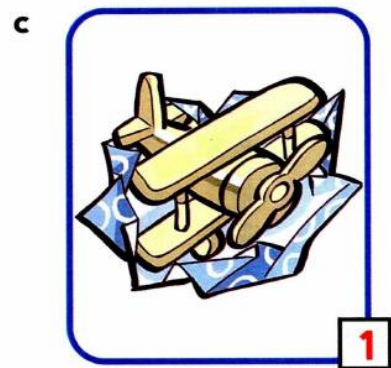
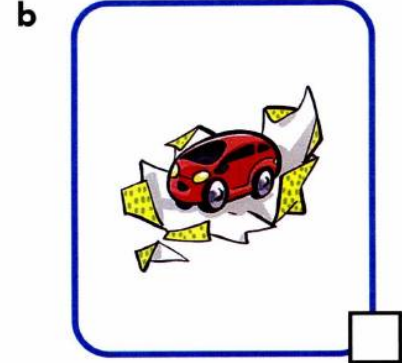
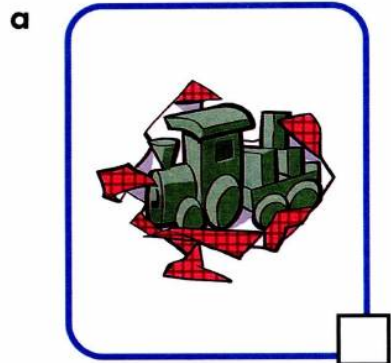

THINK BIG Find, circle and say.



4 Look, match and say.

1



2



3



4

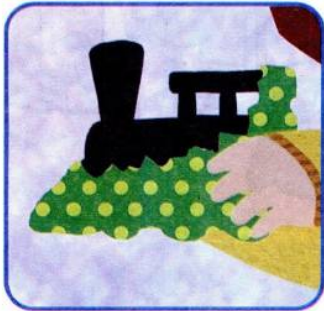

a



b



c



d





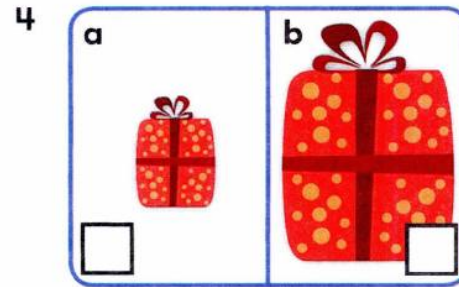
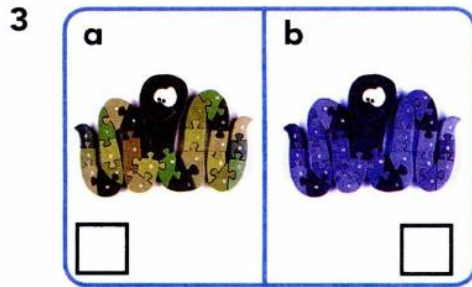
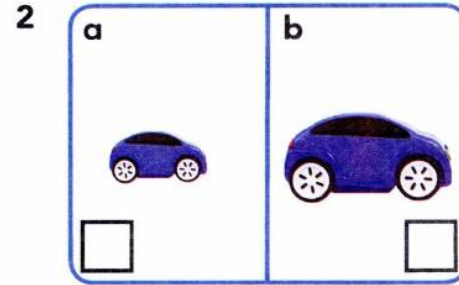
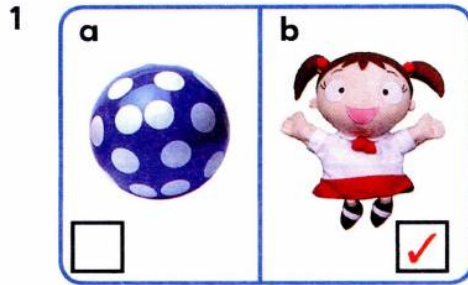

5 Listen and ✓.

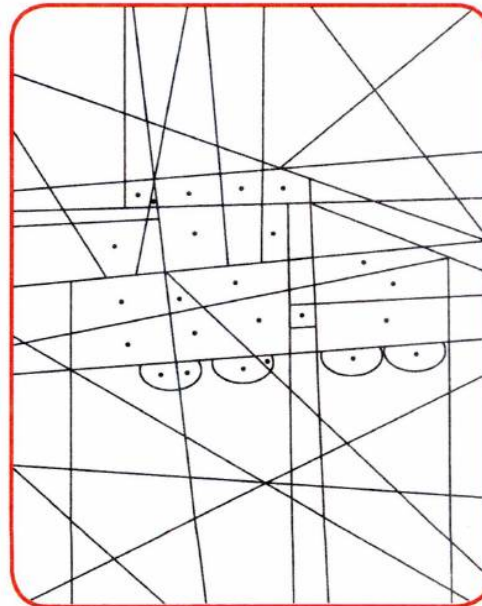
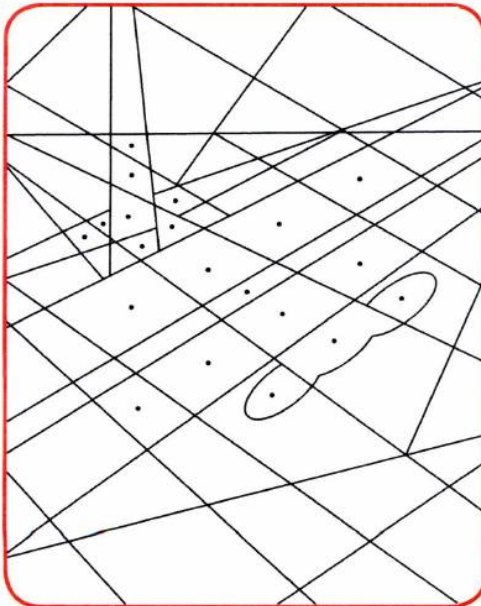

6 Find, colour and say.



7 Listen and ✓.

				
1				✓
2				
3				
4				

8 Find, match and say.

1 

2 

3 

a 

b 

c 



Listen and number.



**THINK
BIG**

Look, match and say.

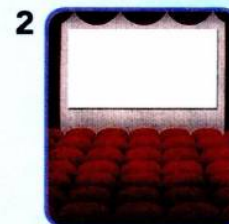

 Listen and match. Say.

1

2

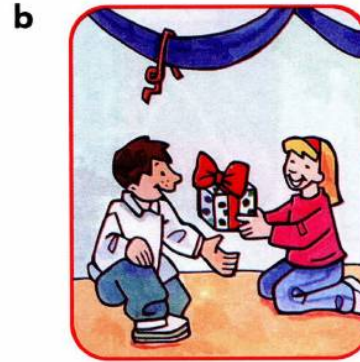

 Draw and say.

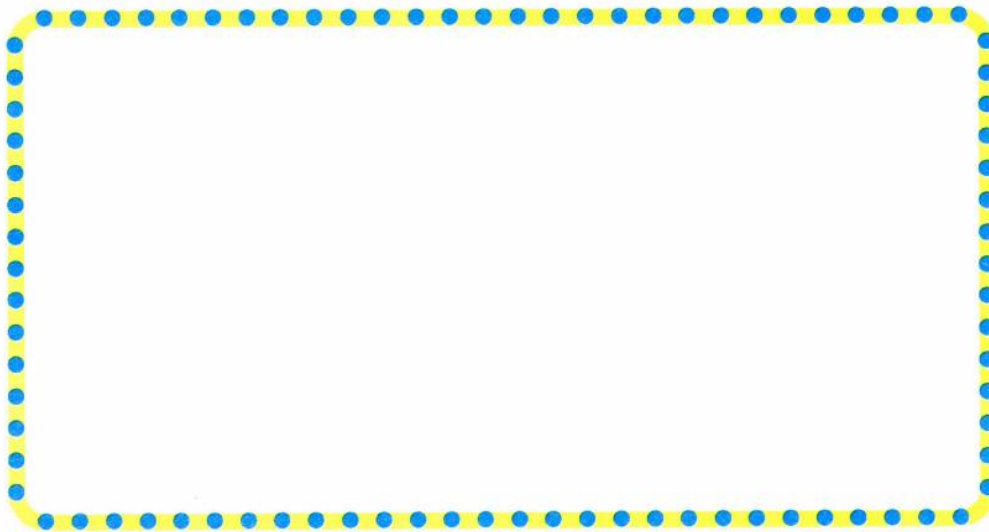

12 Find and colour. Say.



Review

13 Look and draw. Say.

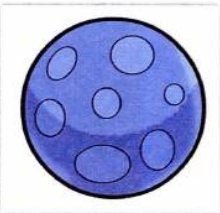
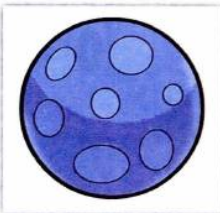
1				
2				
3				

14 Count and draw. Say.

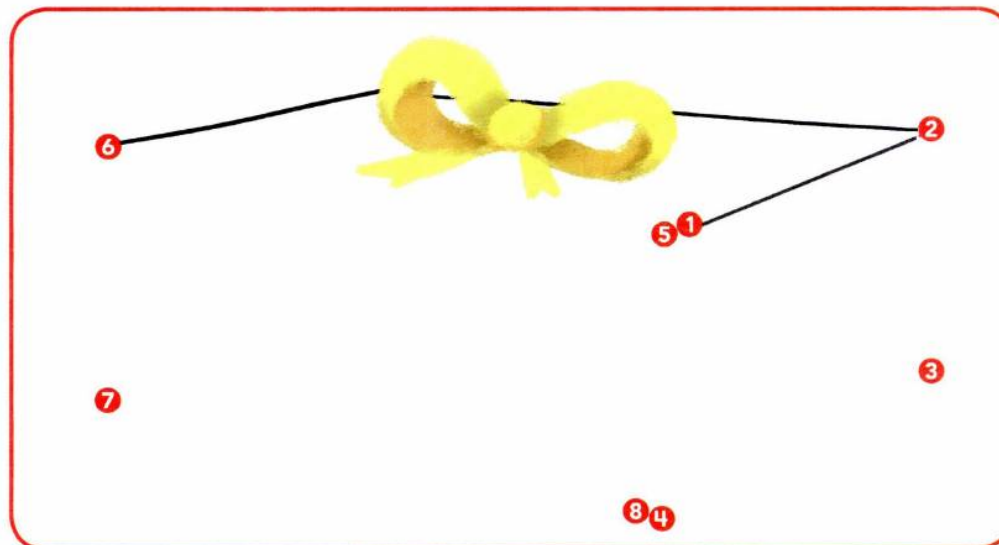

1.65 **15** Listen and ✓.

1 a



b



2 a



b

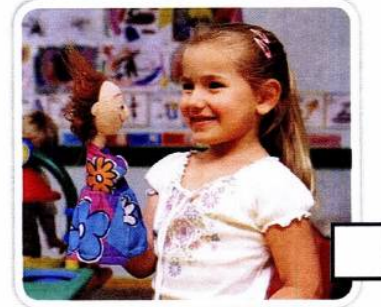

3 a



b



4 a

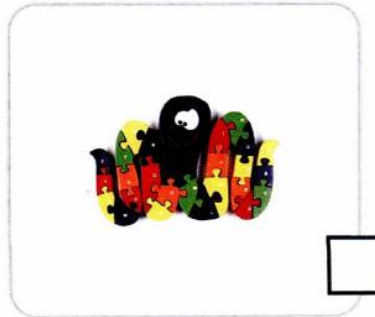

b



unit
3

I like cake!



Listen and number.

a



b



c



d



Match and say.

1



2



3



4



d



3

Listen and circle. Sing.

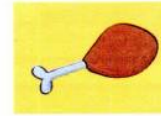

**THINK
BIG**

Look and **X** the odd one out.

1

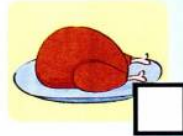

2

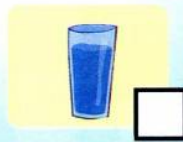

Story

4 Number in order. Tell the story.

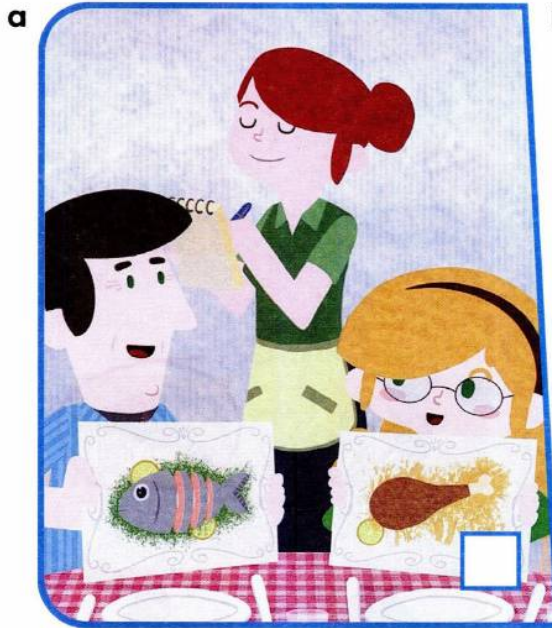

5 Listen and match.

1



2



3



4

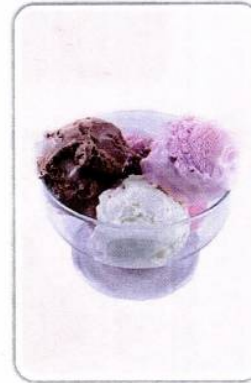

5





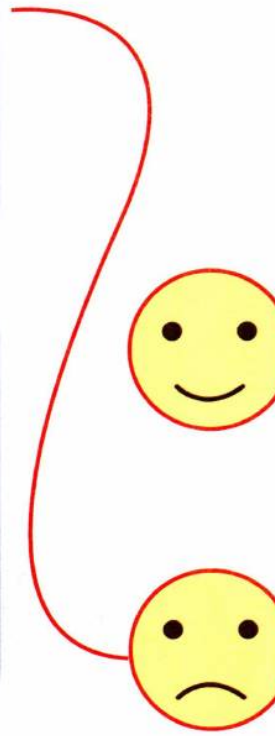
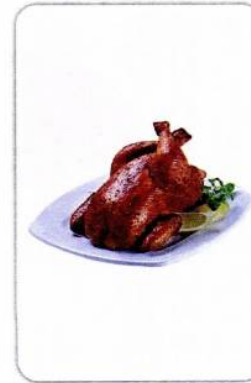











6







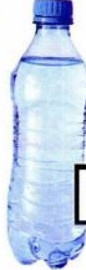

Language in Action

6 Listen and draw.

				
				
2 				

7 Look and ✓ or ✗ for you. Say.

			
<input type="checkbox"/>	<input type="checkbox"/>	<input type="checkbox"/>	<input type="checkbox"/>
			
<input type="checkbox"/>	<input type="checkbox"/>	<input type="checkbox"/>	<input type="checkbox"/>

8 Look and colour. Say.



=



2



=



4



1



3



THINK BIG Look, match and say.

1



3



2



4





Listen and number.

a

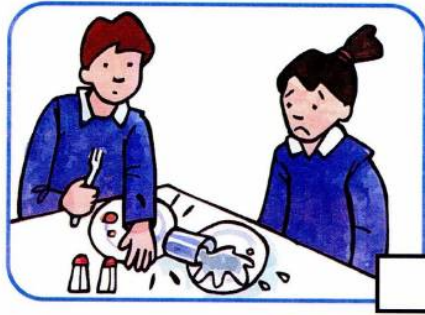

b

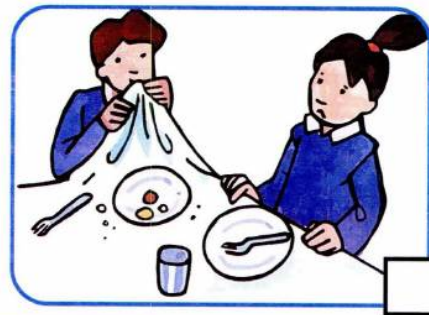

c

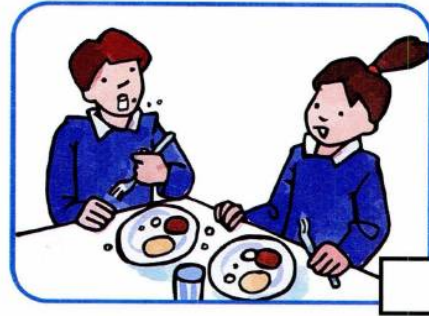

10 Draw and say.

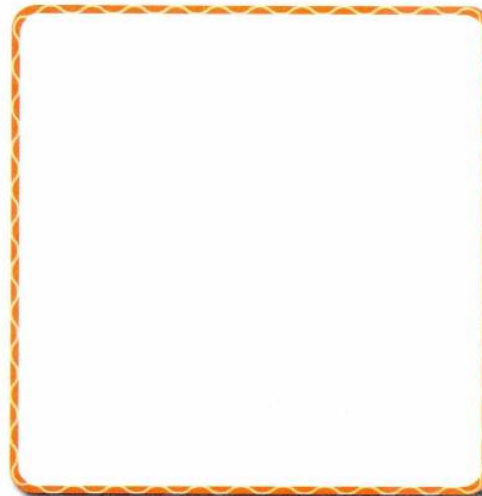
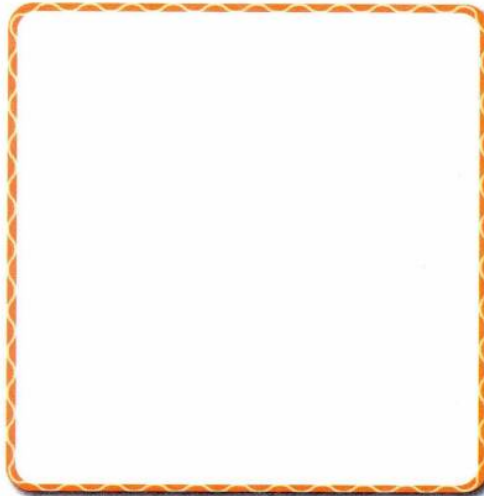

 Look and match.

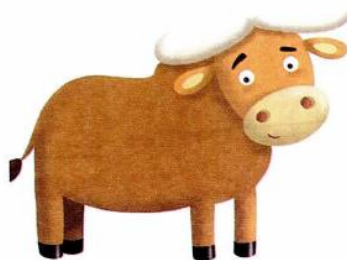
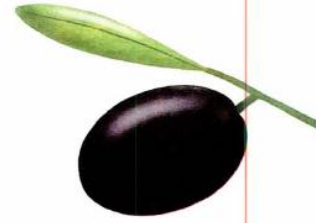
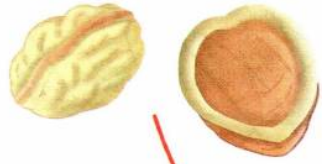

12 Colour and find.

1

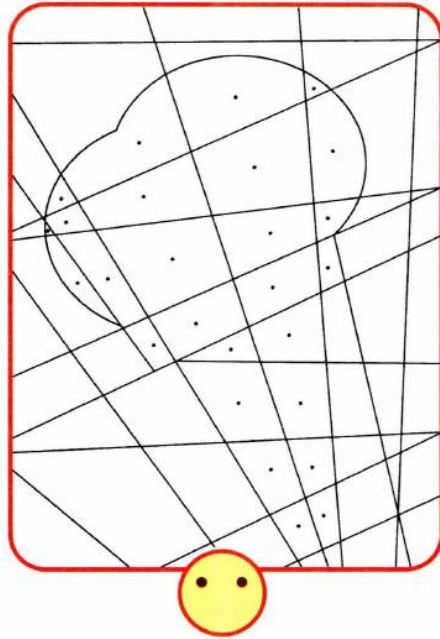

2

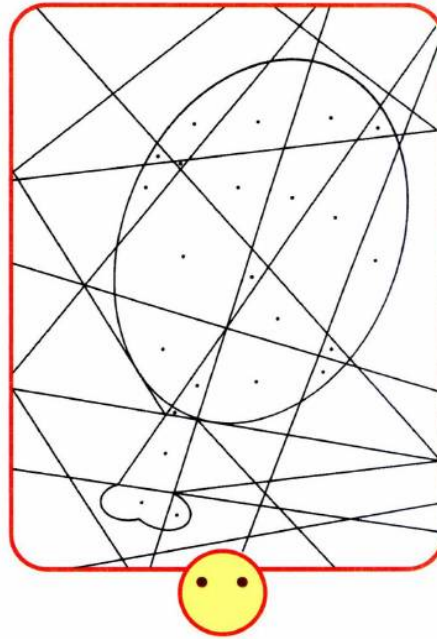

3

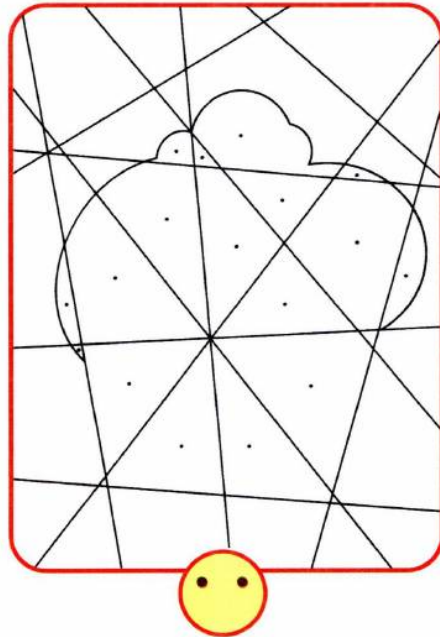

4

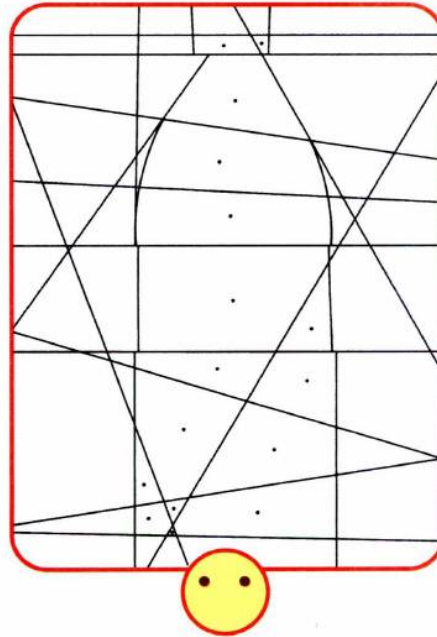

13 Listen and ✓ or X.

1

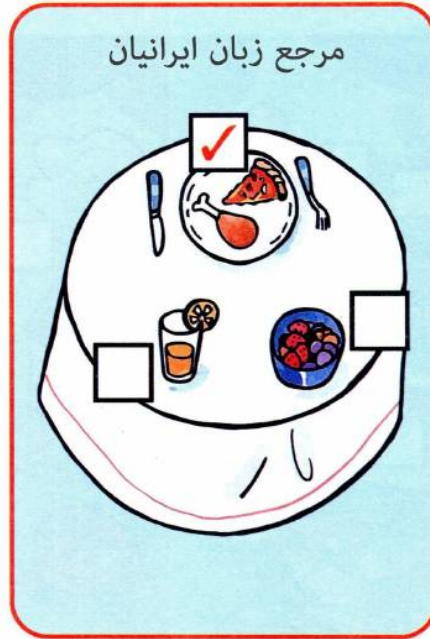

2



3

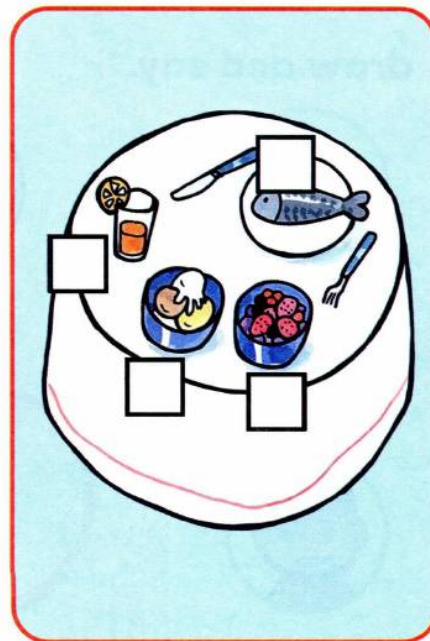

4



Think Big

1 Listen and number.

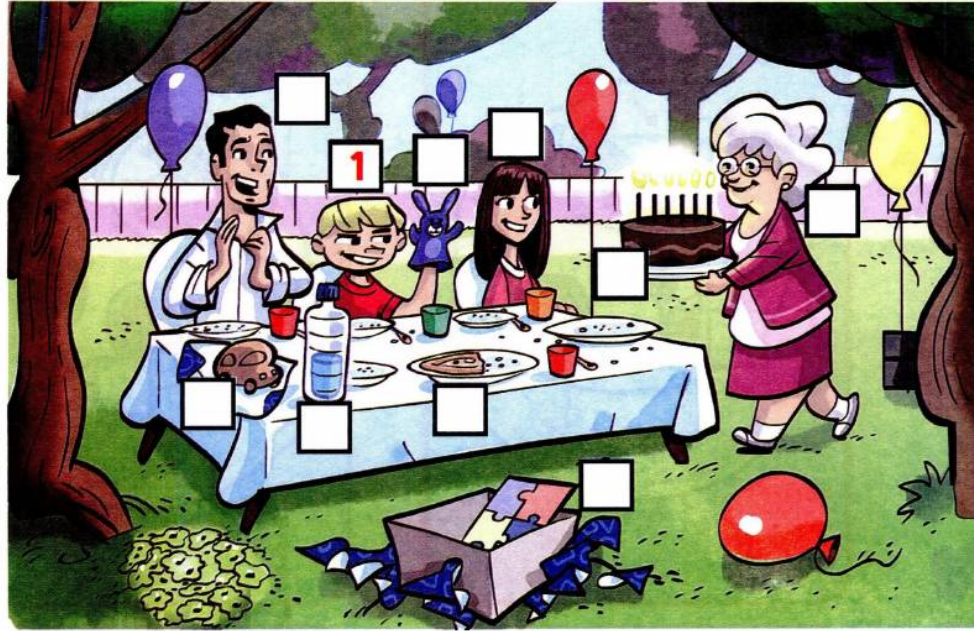

2 Who's missing? Look, draw and say.

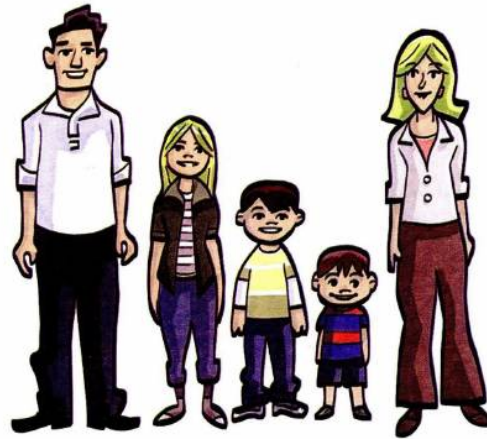



3 Listen and colour.

1 a



b



2 a



b

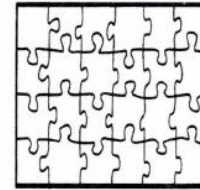

3 a

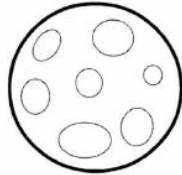

b



4 a



b



4 Look and match for you.

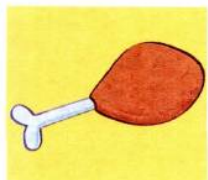

unit
4

My Body



Listen and number.

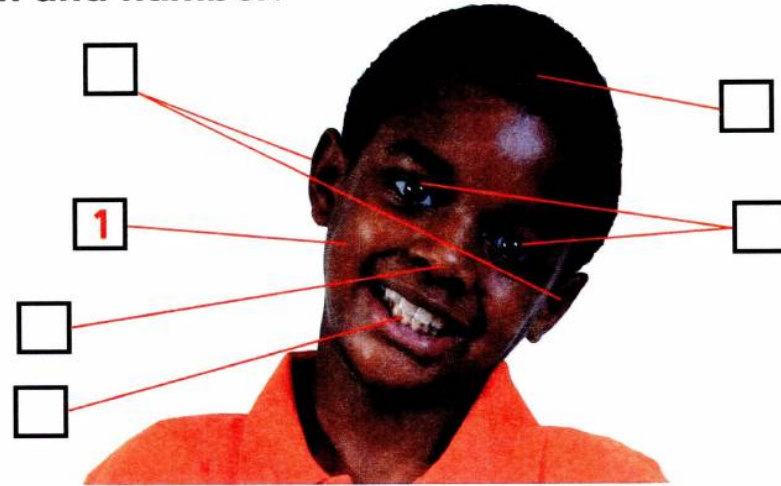

Complete and say.





Listen and draw. Sing. 🎵

1



2



3



**THINK
BIG**

Count and write. Say.

مرجع زبان ایرانیان

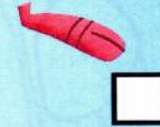
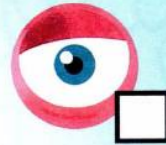
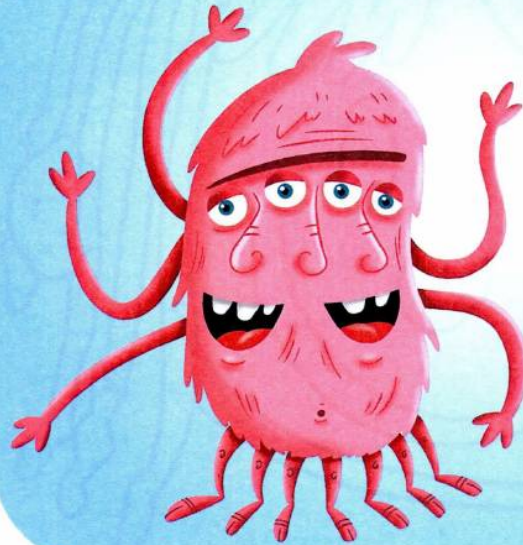

Story



4 Listen and number.

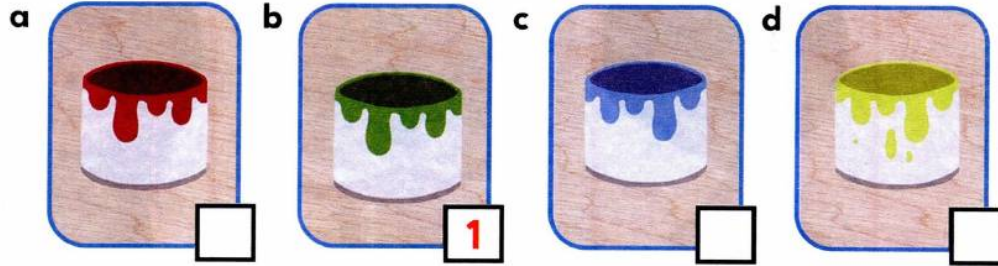

5 Look at 4 and colour. Say 2 differences from the story.

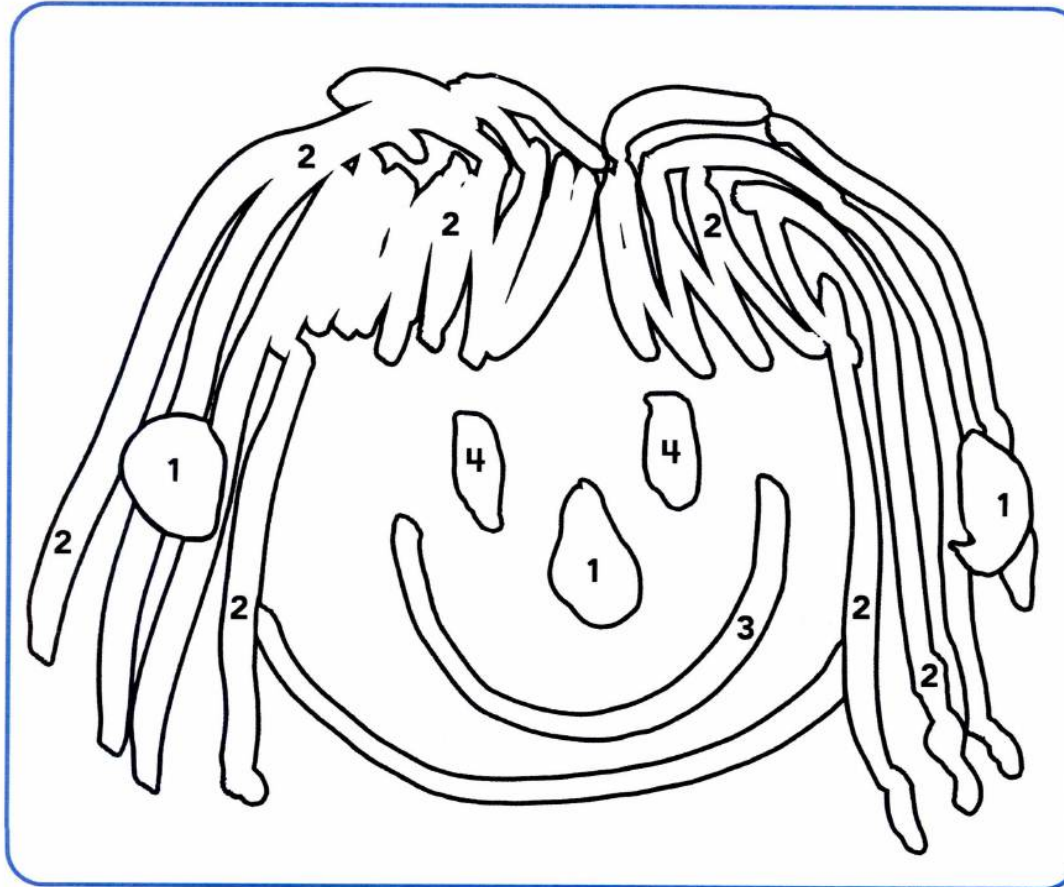



Listen and circle.

1 a

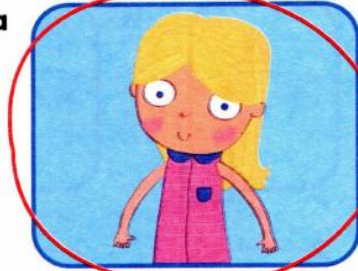

b



2 a

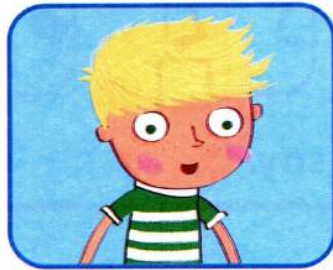

b

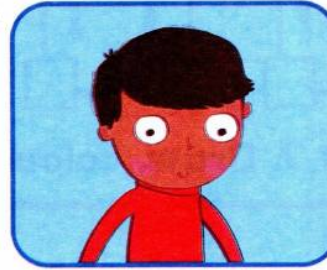

3 a



b



4 a



b



7 Listen and ✓.

1 a



b

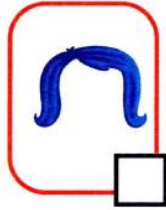

2 a

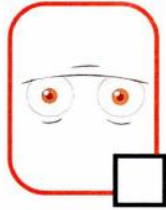

b

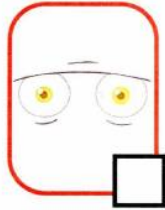

3 a



b



4 a



b



8 Look at 7. Draw, colour and say.

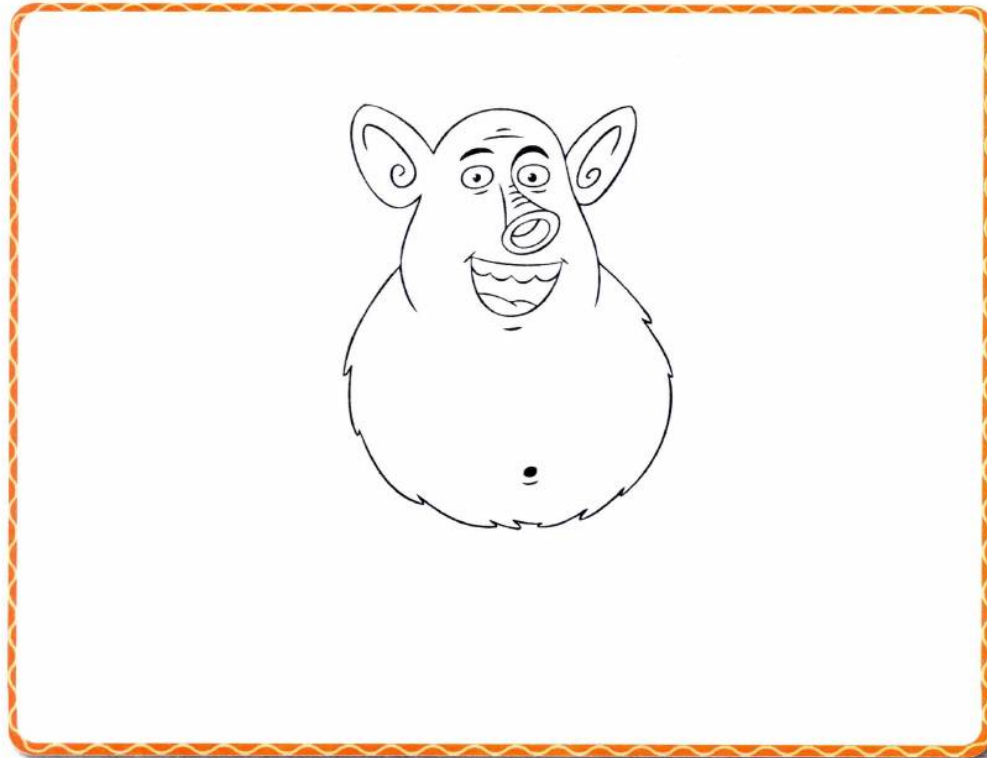

9 Listen and ✓ or X.



THINK BIG Look and draw 😊 or ☹️.

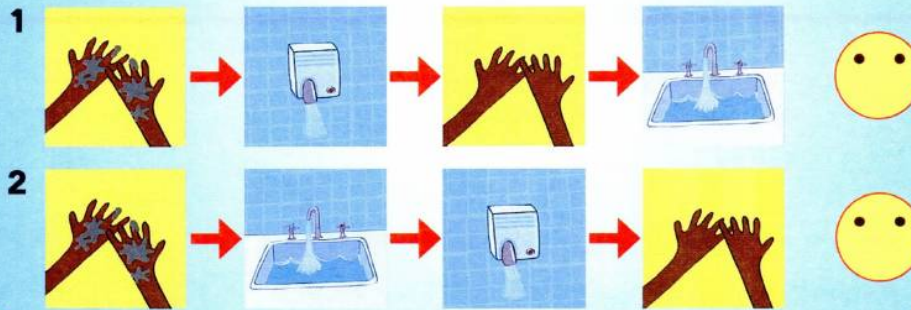

10 Count and draw. Say.

1

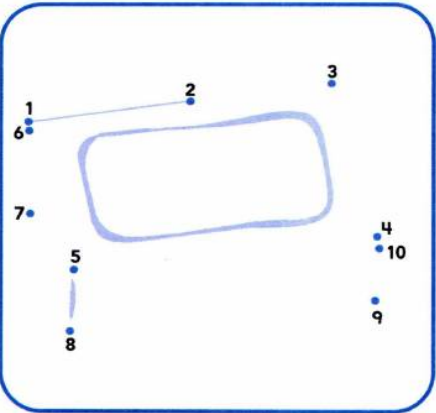

2

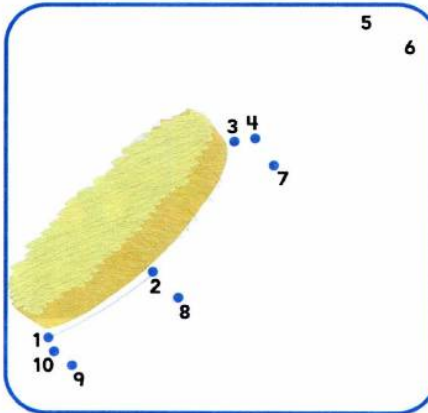

3

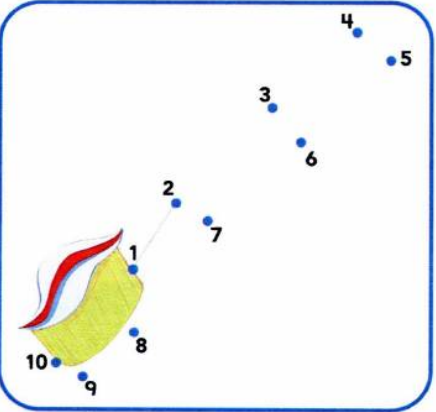

11 Draw and say.



12 Find and colour. Say.

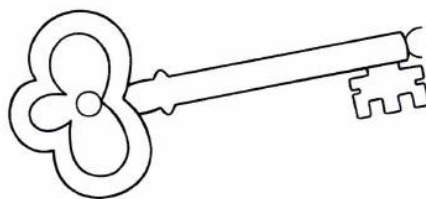
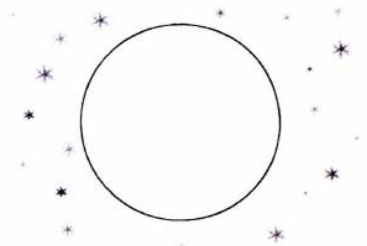
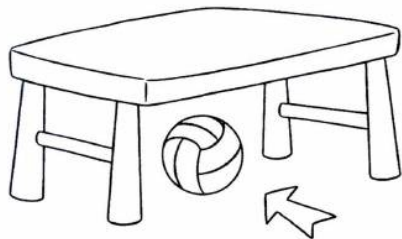
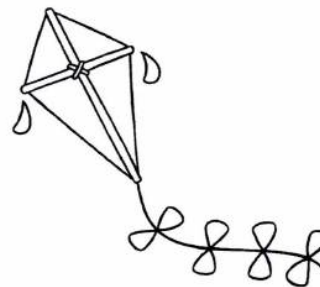
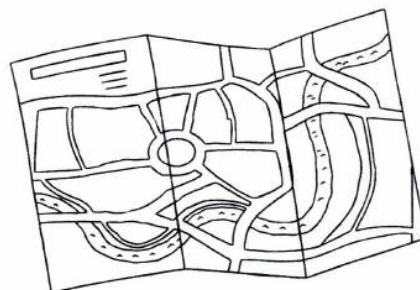

Review

13 Look and circle the odd one out.

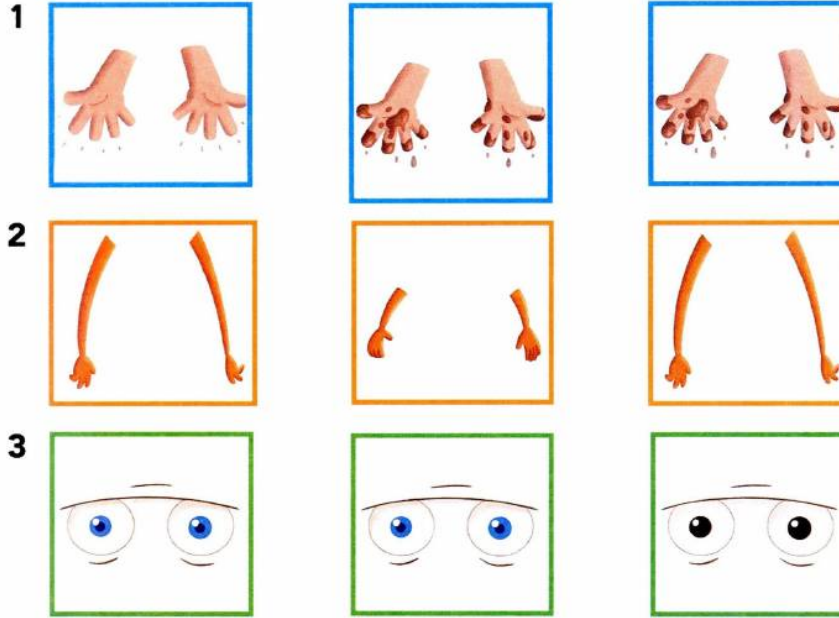

14 Draw and say.

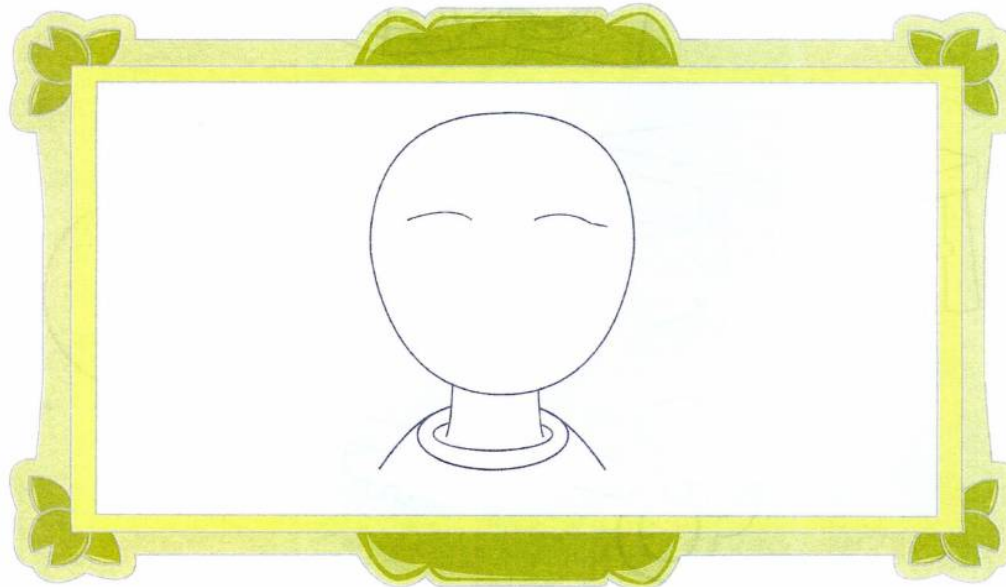





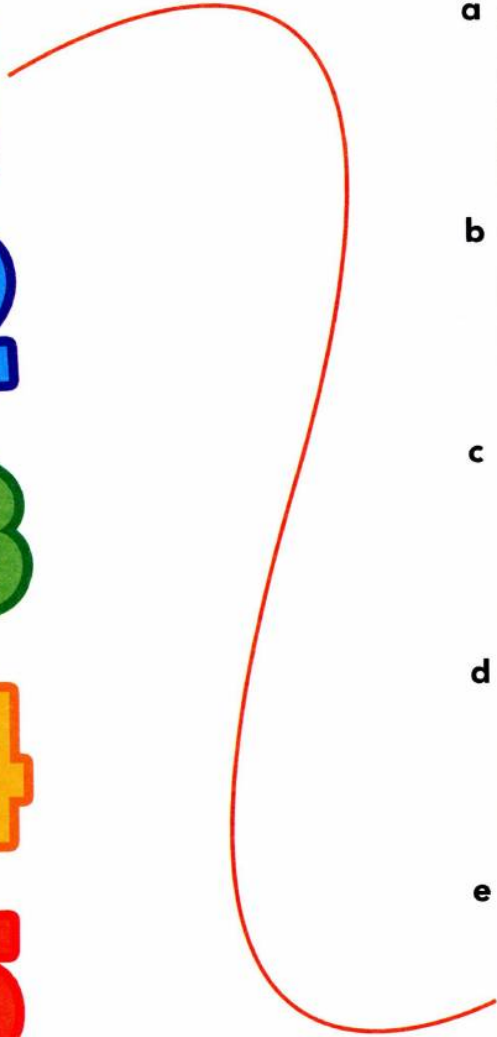

15

Listen and match.

- 1
- 2
- 3
- 4
- 5
- 6



- a 
- b 
- c 
- d 
- e 
- f 

unit 5

Around Town



Listen and ✓.

1 a



b



2 a



b



3 a



b



4 a



b



Match and say.

1



2



3



a



b



c



2:34 **3** Listen and number in order. Sing. 🎵



THINK BIG Look and draw. Say.



Story

4 Number in order. Tell the story.

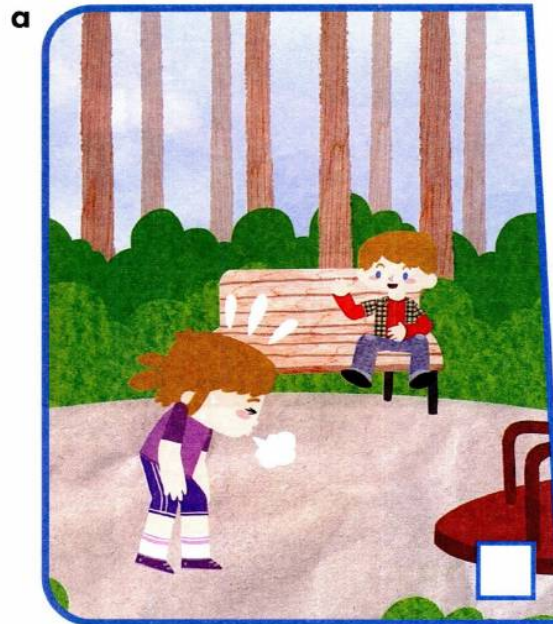

 5 Listen and draw.

1

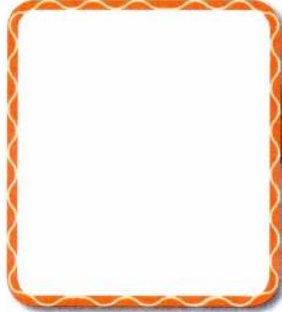

2



3











4



Language in Action

6 Listen and number.

				
				
				
		1		
				

7 Draw and say.

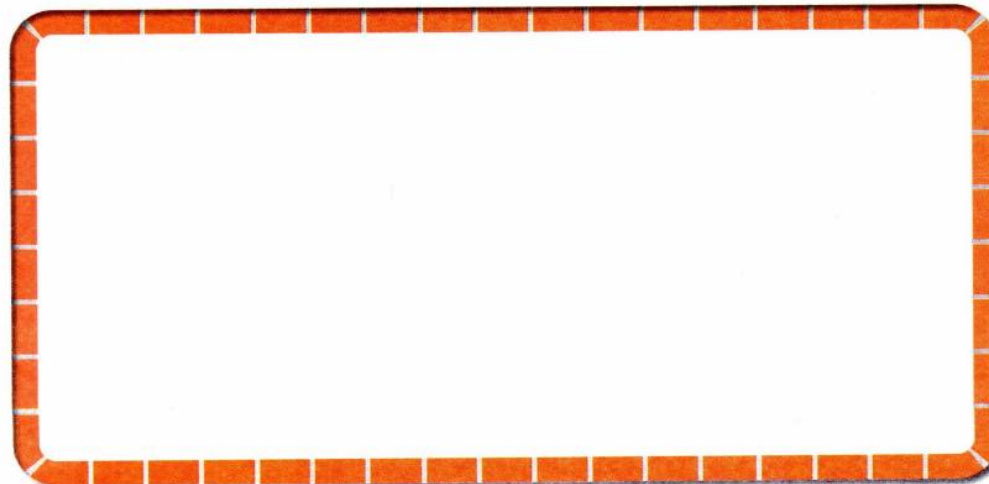

8 Complete and say.

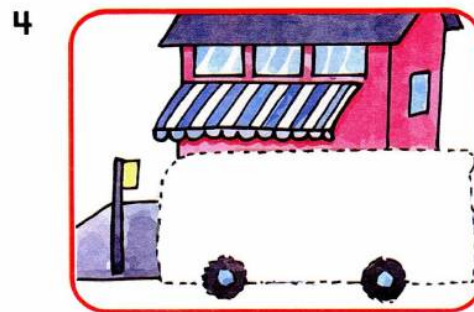
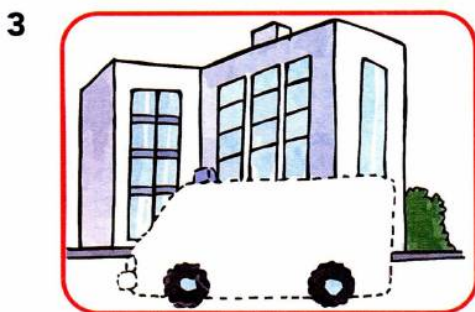
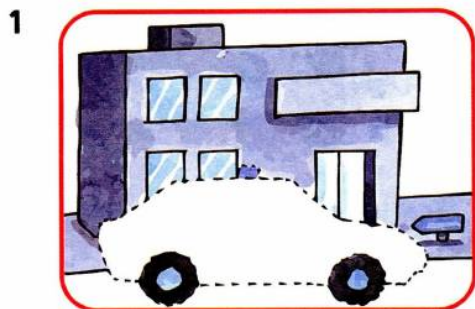

THINK BIG Look and ✓ or ✗.

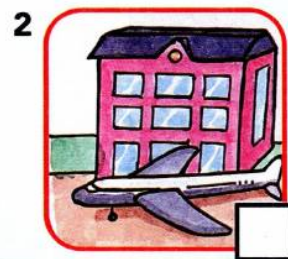
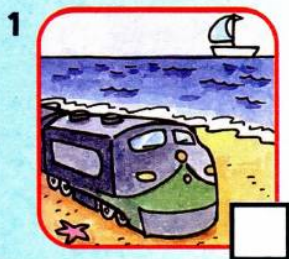

9 Look and circle. Say.

1



2



3



4















10 Look and match.



Review

11 Look. Match and say.

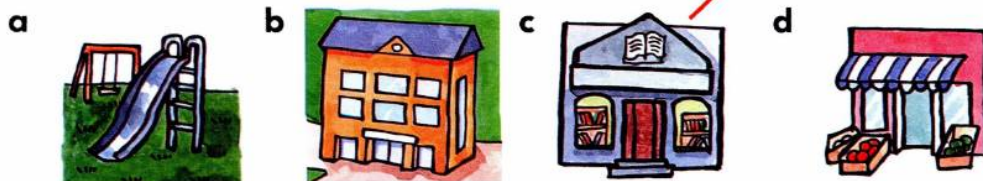

12 Listen and circle.

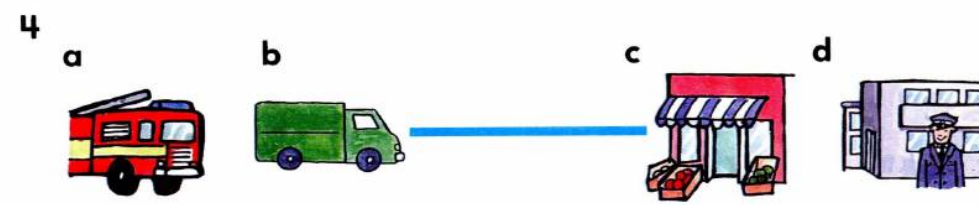
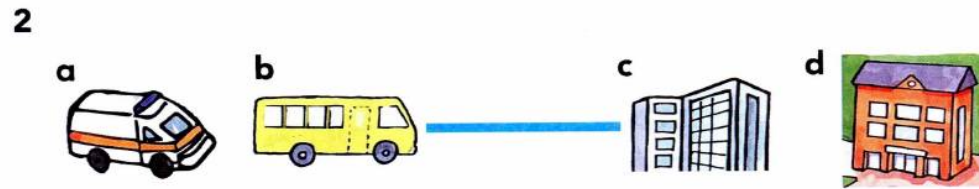
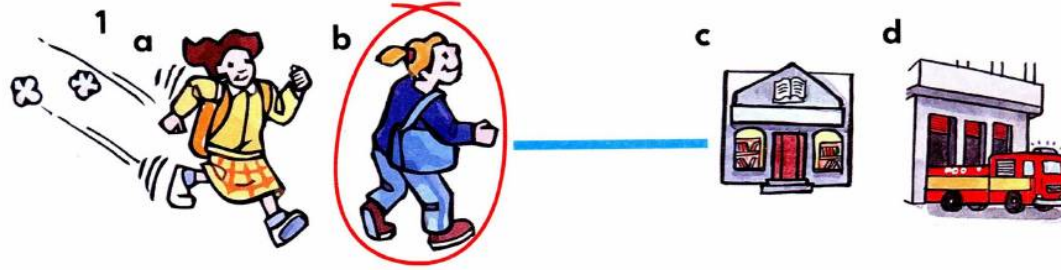

unit
6

She's swinging on the swings!



1 Listen and colour.

a



b

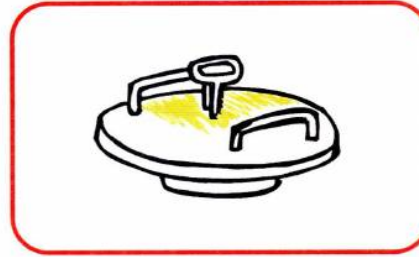

c

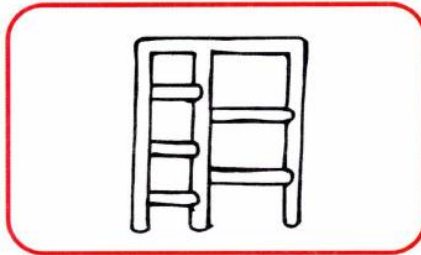

d

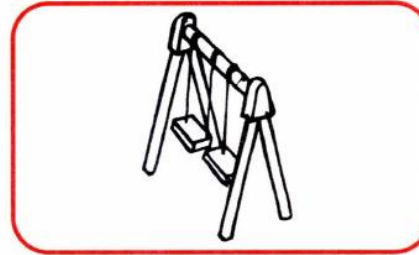

2

Complete and say.

1



2



3



4



2:54
3

Look and match. Listen, number and sing. 🎵

a



b



c



d

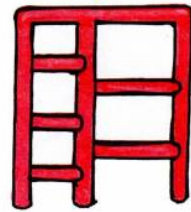

**THINK
BIG**

Look and number. Say.

1



2



3



a



b



c



مرجع زبان ایرانیان

4 Look and match. Say.

1



2



3



4



5

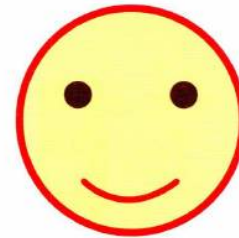



Listen and number.



Draw and say.

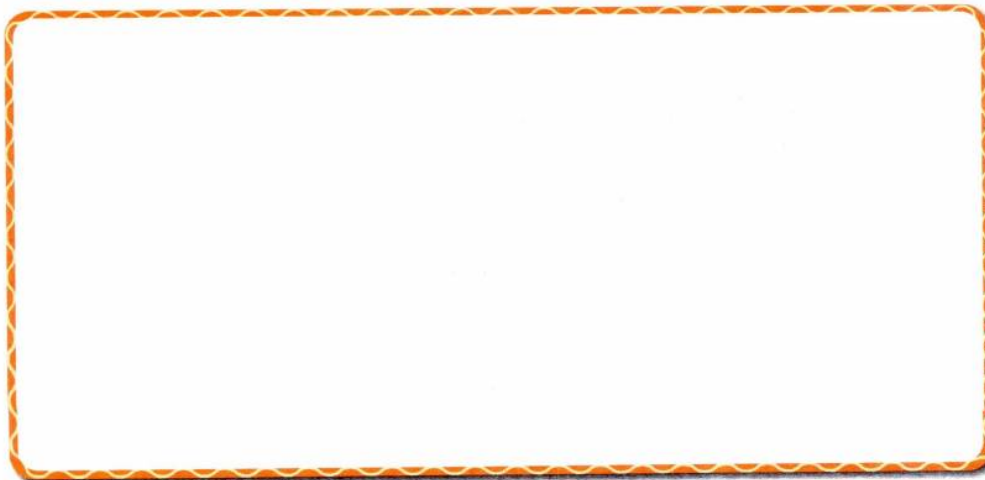

Language in Action



Listen and ✓ or ✗.

1



2



3



4

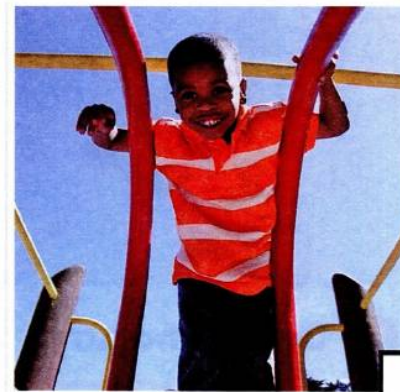

5



6

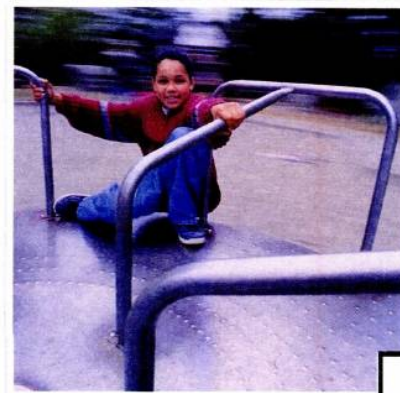

8 Number in order. Say.

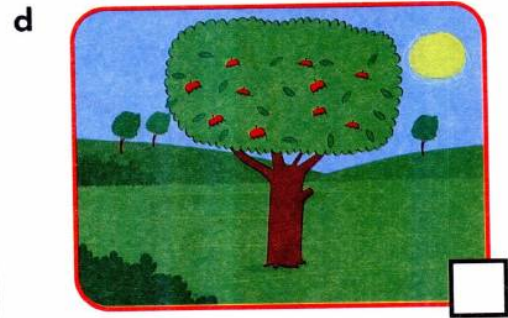
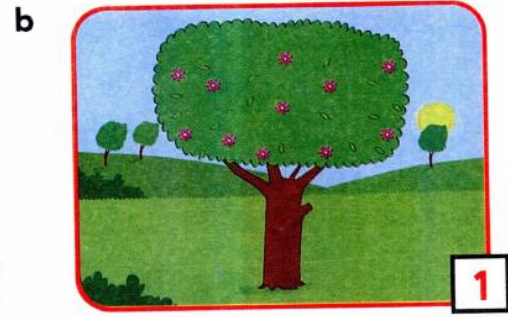
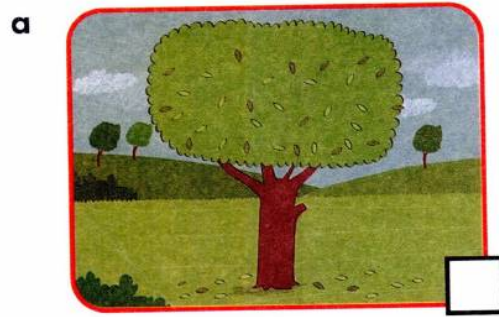

THINK Look and draw.
BIG

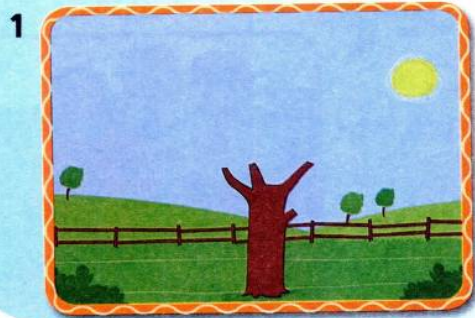

9 Look and match. Say.

1

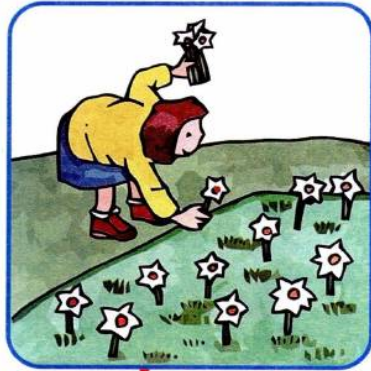

2



3



4





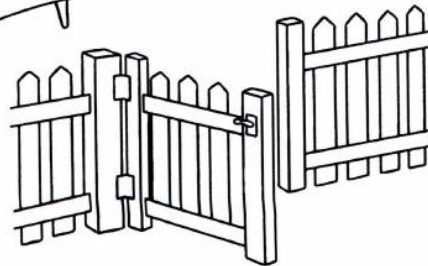
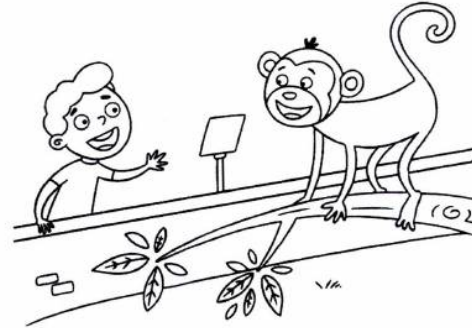
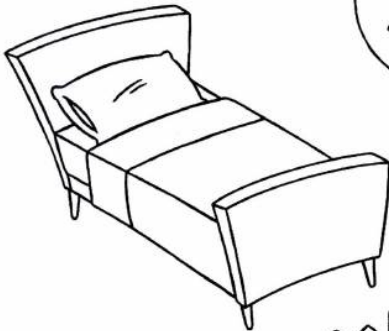
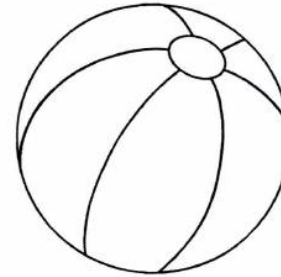
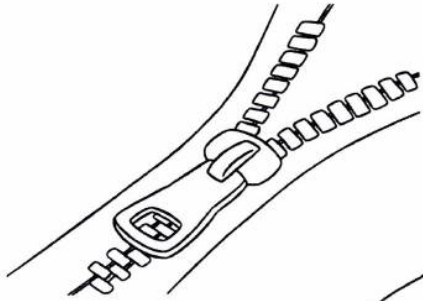
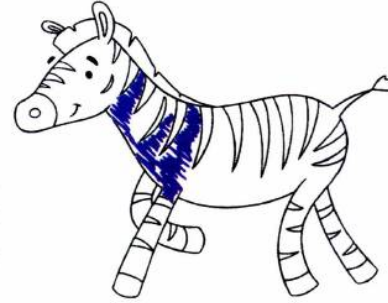





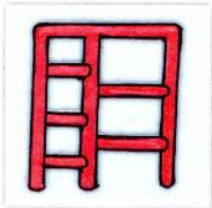

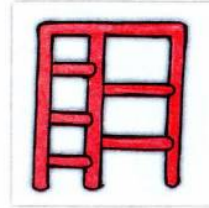
10 Find and colour. Say.



Review

11 Look and draw. Say.

1				
2				
3				

12 Look and ✓ or ✗. Say.

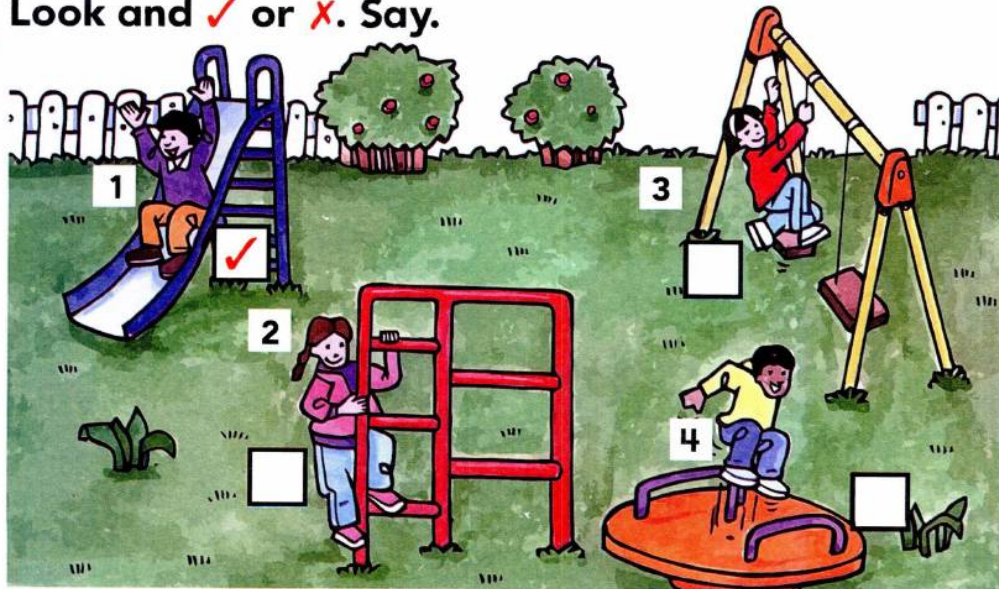



Listen and circle.

1 a



b



2 a



b



3 a



b



4 a



b



5 a



b



6 a



b

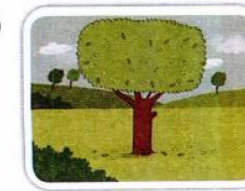

Think Big

1 Listen and number.



2 Look and draw. Say.

1

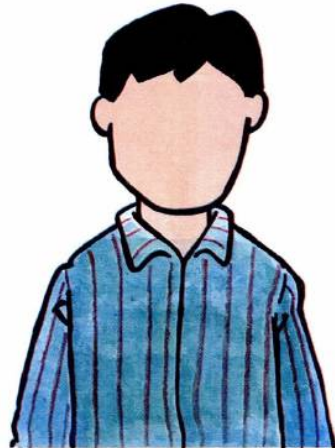

2



3 Listen and match.

1



2



3



4



a

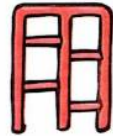

b



c



d



4 Look and ✓. Draw and say.

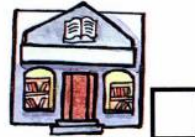
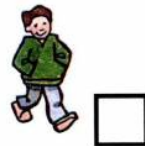

unit
7

It's sunny!



Listen and match.

1

2

3

4

5

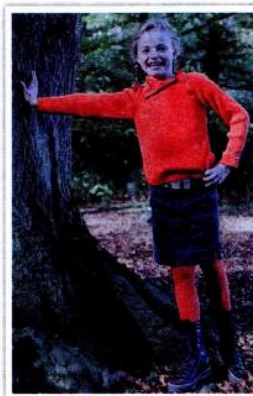
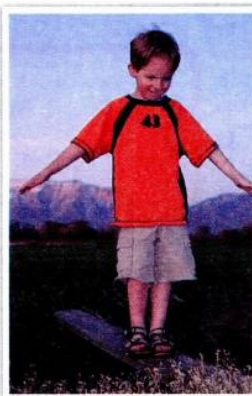
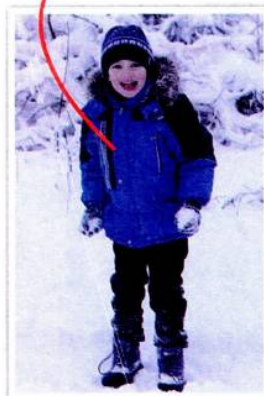

6

7

8

9

10

3:04
2

Listen and draw. Sing. 

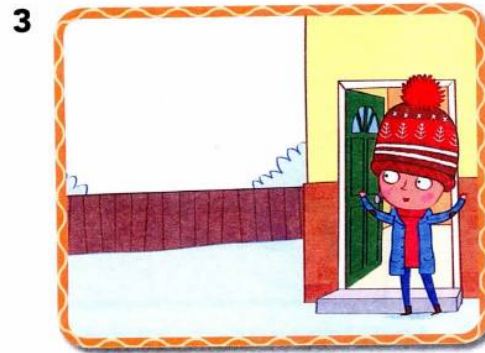

**THINK
BIG**

Look and circle. Say.

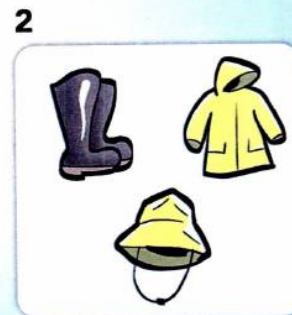

3 Number in order. Tell the story.





Listen and ✓ or X.

1



2



3



4



5



6



5 Listen and number. Say.

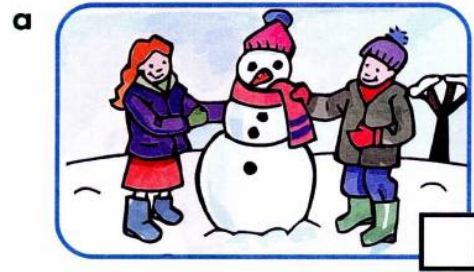

What are you wearing? Colour and say.

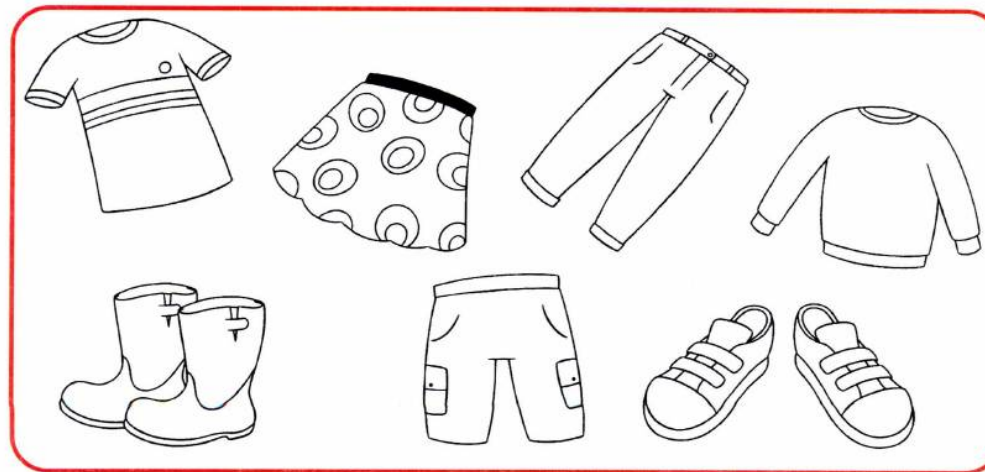

7 Look and colour. Say.

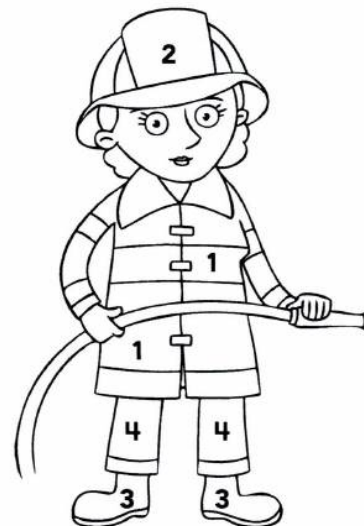

THINK BIG Look and match.



8 Listen and number.

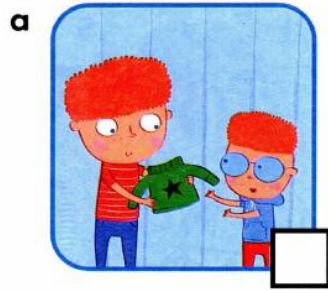

9 Look and draw. Say.

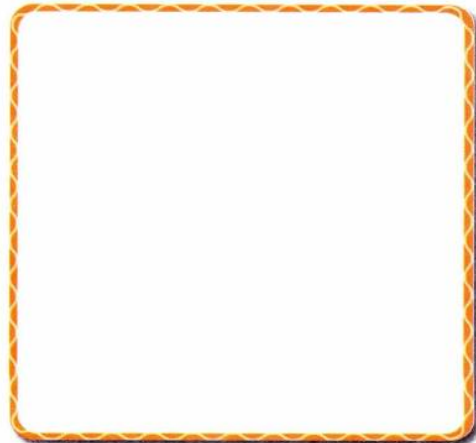
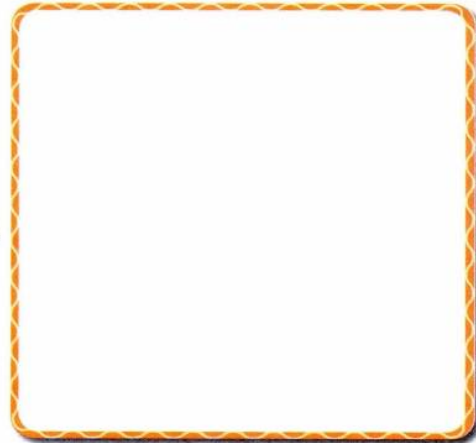

10 Look and match.

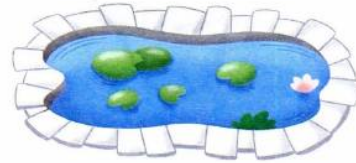

Review

11 Circle the odd one out. Say.

1



2



3



4



 12 Listen and match.

1

2

3

4

5

6



unit
8

My House



Listen and number.

a

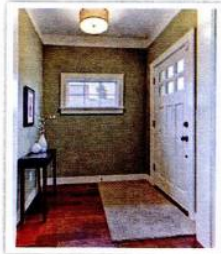

b



c



d



e



f

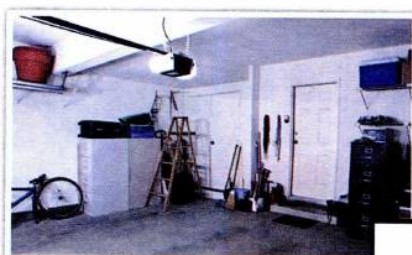

g



h



www.irLanguage.com



Look, listen and draw. Sing. 🎵



**THINK
BIG**

Look and ✓. Say.



Story

3 Match and say.

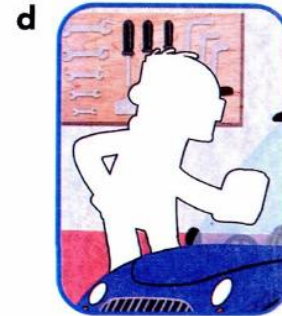
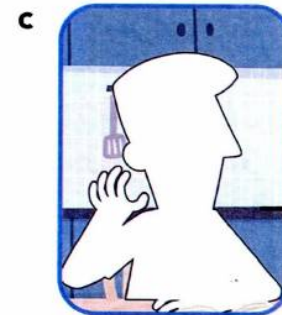
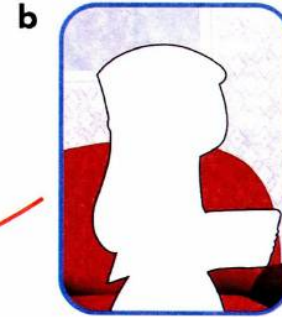



Listen and ✓ or ✗.

1



2



3



4

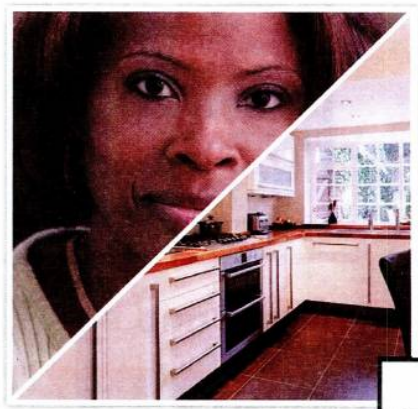

5

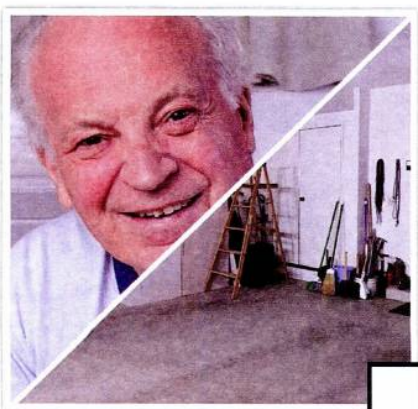



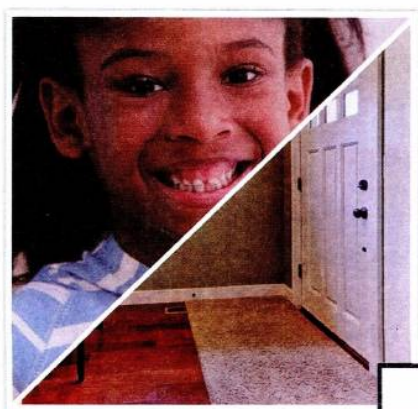





6



Language in Action

5 Listen and ✓.

				
1 			✓	
2 				
3 				
4 				

6 Draw and say.



7 Look and number. Say.

1



2



3



4



a



b



c

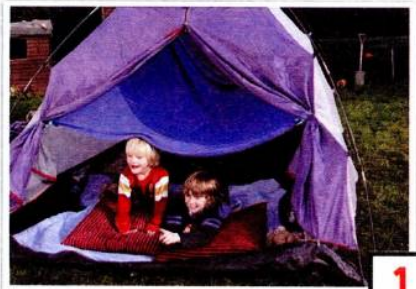

d

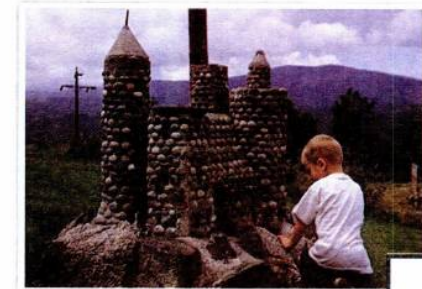

**THINK
BIG**

Circle the odd one out. Say.



8 Look and circle.

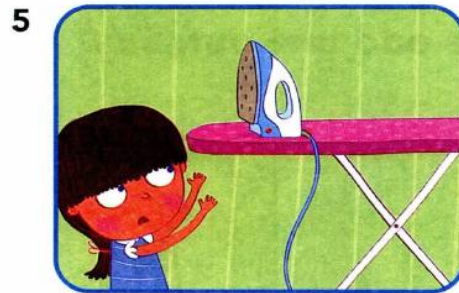

9 Find and colour. Say.

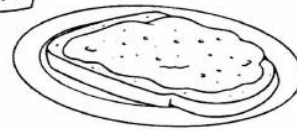
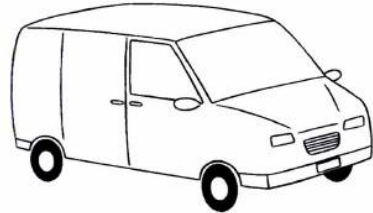

Review

10 Complete and draw. Say.

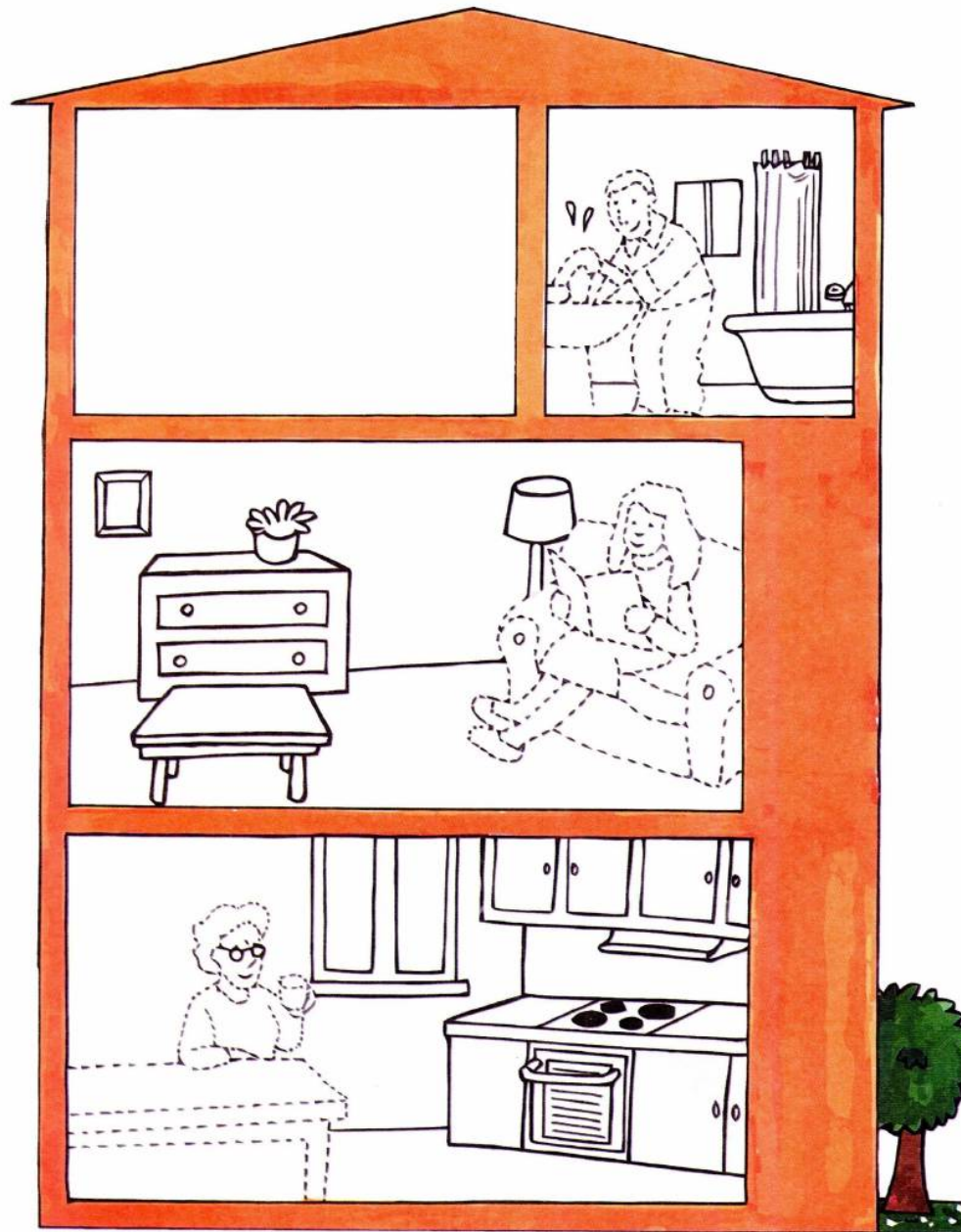

345  Listen and ✓.

1 a



b



2 a



b



3 a



b



4 a



b



5 a

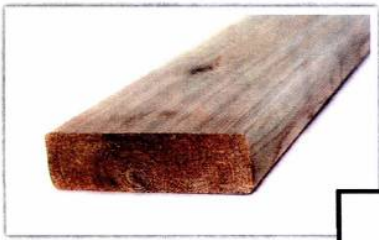

b



unit
9

A fish can swim!

1 Listen and follow.

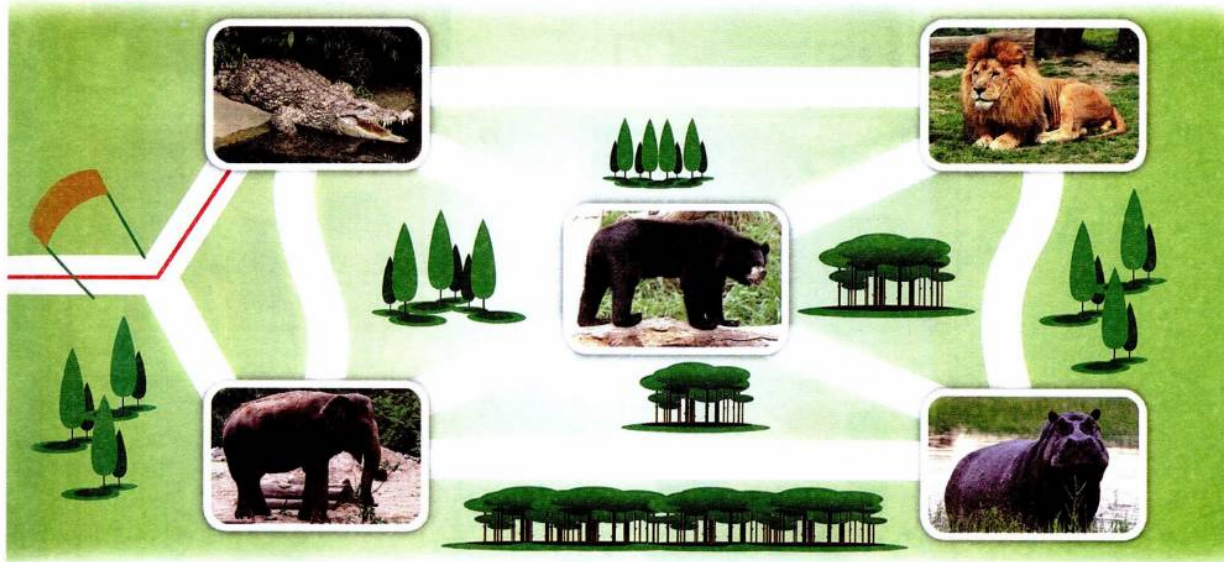

2 Count and draw. Say.

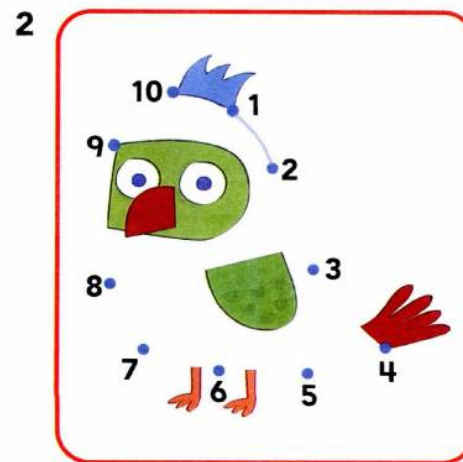
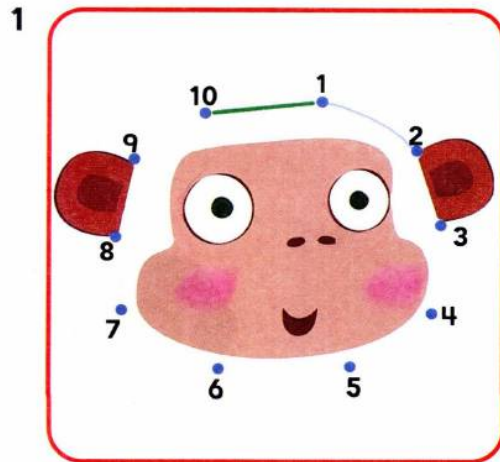

3

Listen and number in order. Sing. 🎵

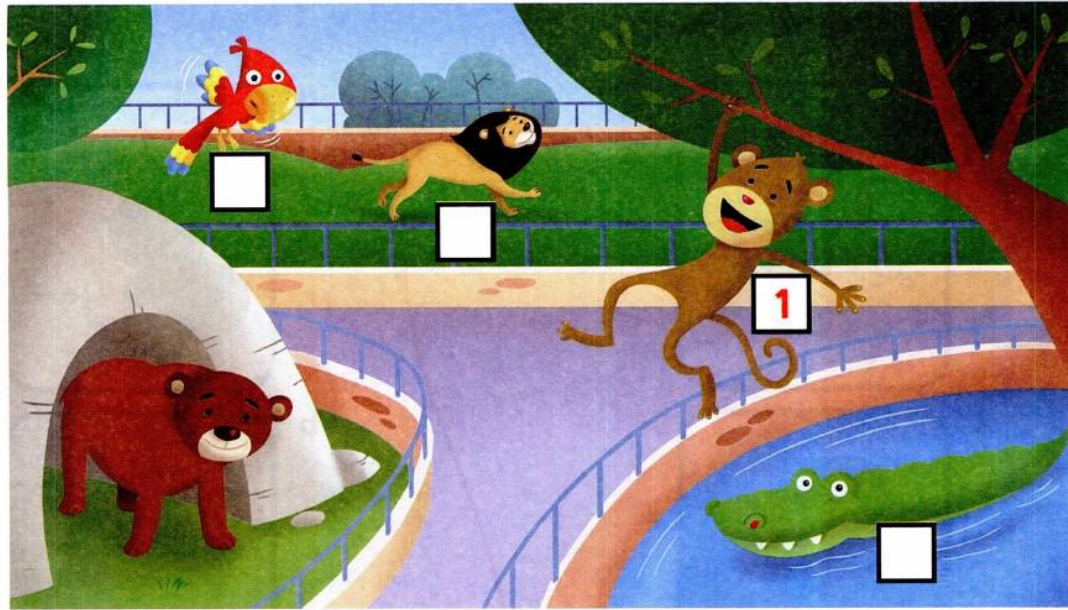

**THINK
BIG**

Look and draw. Say.



4 Match and say.

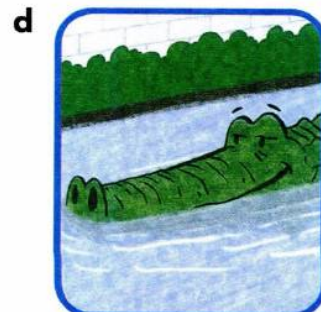
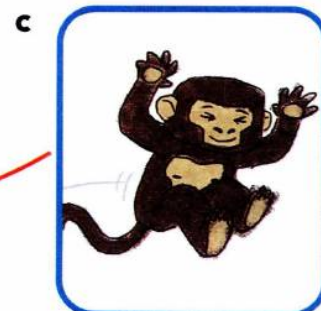
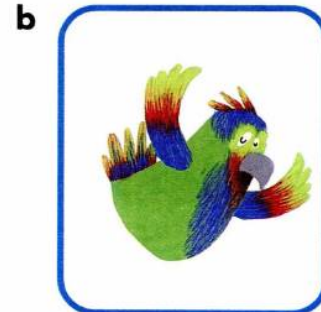
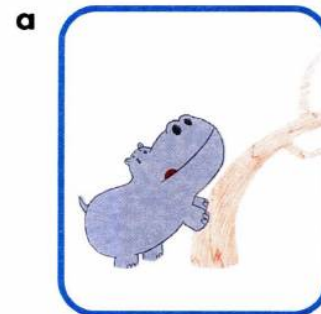
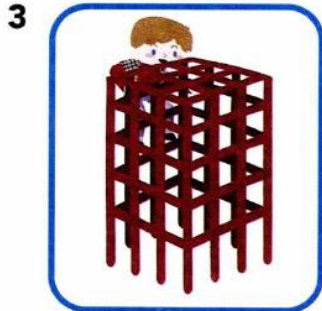

5 Look and ✓ or ✗. Listen and check.

1



2



3



4

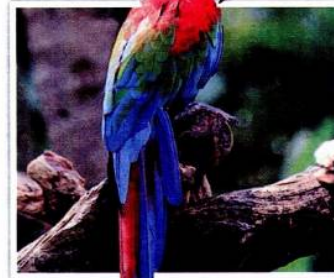

5



6



6 Listen and circle.



7 Look and ✓ or ✗ for you. Say.



8 Look and draw. Say.

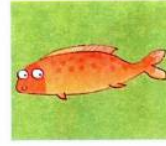

1

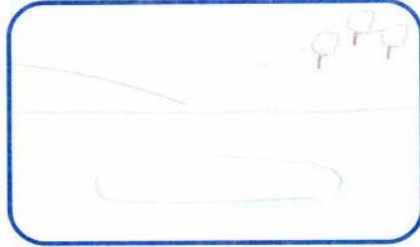

2



3

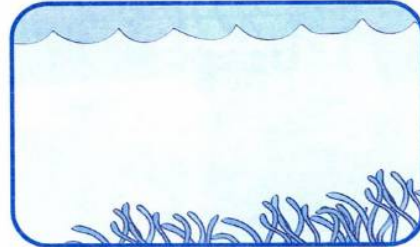

4

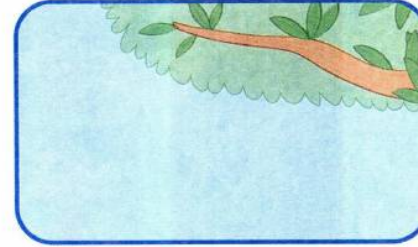

THINK BIG Look and ✓. Say.









9 Look and match. Say.

1



2



3



4



10 Look and match. Say.



11 Look and ✓. Draw.

1



2



3



4

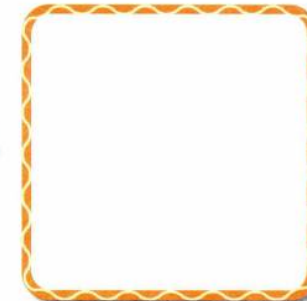

12 Listen and ✓.

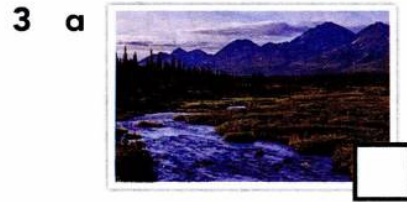

Think Big

1 Listen and number.

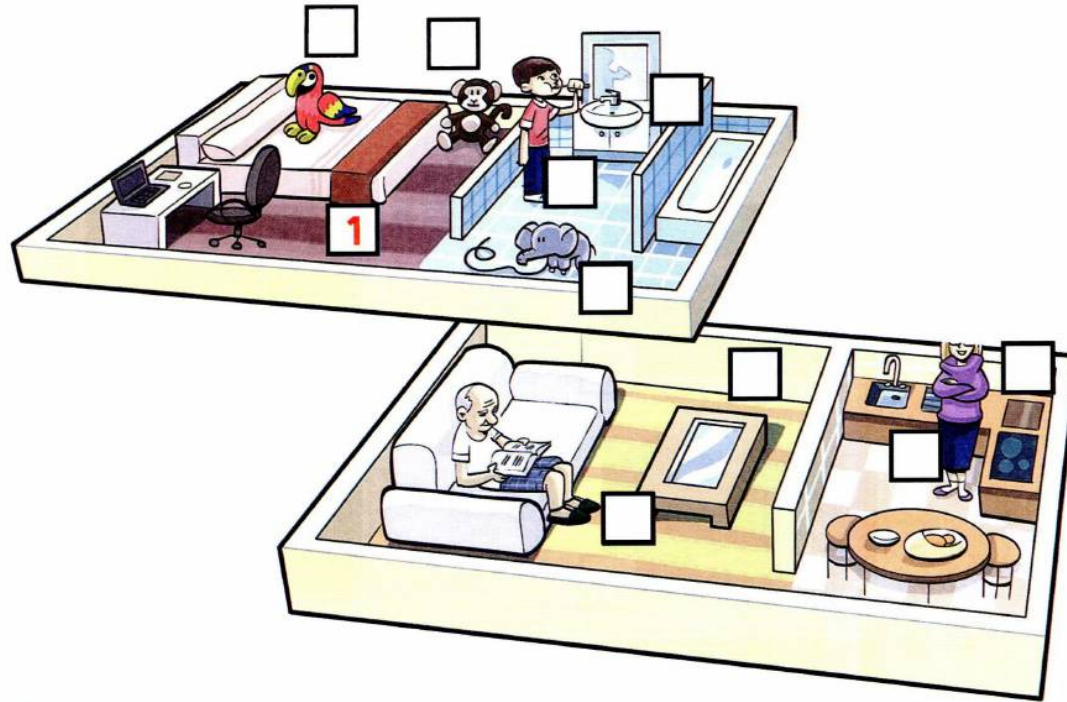

2 Look and draw. Say.

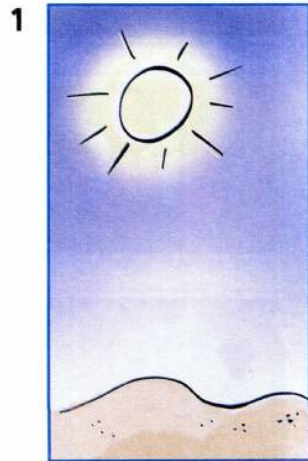



Listen and ✓.

			✓	

irLanguage.com



Match and draw. Say.

1



3



5

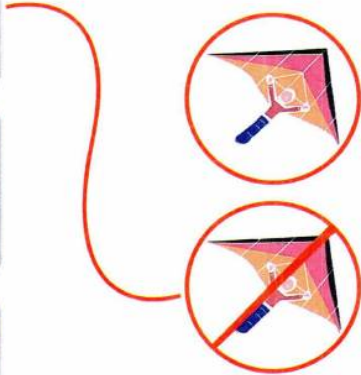

2



4



6



Unit 1 Stick and say.



Unit 2 Stick and say.



Unit 3 Stick and say.



Unit 4 Stick and say.



Unit 5 Stick and say.



Unit 6 Stick and say.



Unit 7 Stick and say.

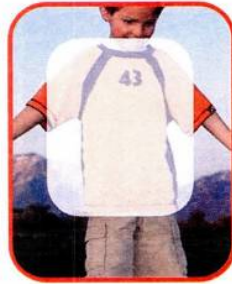

Picture Dictionary

Unit 8 Stick and say.

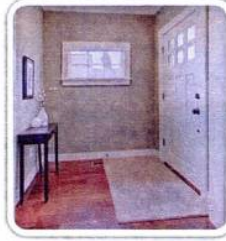

Unit 9 Stick and say.



Unit 1, page 100

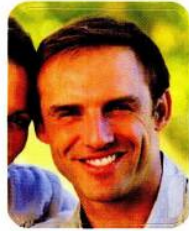

Unit 2, page 100



Unit 3, page 101



Unit 4, page 101



Unit 5, page 102



Unit 6, page 102



Unit 7, page 103



Stickers



Unit 8, page 104

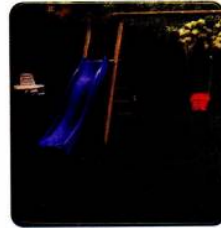
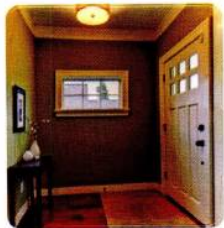

Unit 9, page 104



Share in your pupils' success
Watch them excel in English

Big English prepares pupils for the challenges they will find in today's world:

- **CLIL:** because pupils are learning English and so much more
- **21st Century Skills:** because pupils want to get ahead and need to be prepared for the world around them
- **Assessment for Learning:** because confidence leads to success

Think **BIG** Dream **BIG**

BIG
ENGLISH 

pearsonELT.com/bigenglish

مرجع آموزش زبان ایرانیان

irLanguage.com